

PARTS LIST

WESTERBEKE

60 Hz

4.5 BCGTC

7.2 BCGTC

9.6 BCGTC

4.5 BCGTE

7.2 BCGTE

50 Hz

3.75 BCGTC

6.0 BCGTC

8.0 BCGTC

3.75 BCGTE

6.0 BCGTE

Marine Gasoline Generators

Publication # 044900

Edition One

June 2000



*WESTERBEKE CORPORATION
MYLES STANDISH INDUSTRIAL PARK
150 JOHN HANCOCK ROAD, TAUNTON, MA 02780-7319*

Gasoline with an ETHANOL content higher than 10% (E10) is **not allowed and may void warranty.**



WESTERBEKE™
Engines & Generators

PARTS LIST

WESTERBEKE

60 Hz

4.5 BCGTC

7.2 BCGTC

9.6 BCGTC

4.5 BCGTE

7.2 BCGTE

50 Hz

3.75 BCGTC

6.0 BCGTC

8.0 BCGTC

3.75 BCGTE

6.0 BCGTE

Marine Gasoline Generators

Publication # 044900

Edition One

June 2000



*WESTERBEKE CORPORATION
MYLES STANDISH INDUSTRIAL PARK
150 JOHN HANCOCK ROAD, TAUNTON, MA 02780-7319*

IMPORTANT

PRODUCT SOFTWARE DISCLAIMER

Product software of all kinds such as brochures, drawings, technical data, operator's and workshop manuals, parts lists and parts price lists, and other information, instructions and specifications provided from sources other than Westerbeke, is not within Westerbeke's control and, accordingly, is provided to Westerbeke customers only as a courtesy and service. **Westerbeke cannot be responsible for the content of such software, makes no warranties or representations with respect thereto, including the accuracy, timeliness or completeness thereof, and will in no event be liable for any type of damages or injury incurred in connection with, or arising out of, the furnishing or use of such software.**

For example, components and subassemblies incorporated in Westerbeke's products and supplied by others (such as engine blocks, fuel systems and components, transmissions, electrical components, pumps and other products) are generally supported by their manufacturers with their own software, and Westerbeke must depend on such software for the design of Westerbeke's own product software. Such software may be outdated and no longer accurate. Routine changes made by Westerbeke's suppliers, of which Westerbeke rarely has notice in advance, are frequently not reflected in the supplier's software until after such changes take place.

Westerbeke customers should also keep in mind the time span between printings of Westerbeke product software, and the unavoidable existence of earlier, non-current Westerbeke software editions in the field. Additionally, most Westerbeke products include customer-requested special features that frequently do not include complete documentation.

In summation, product software provided with Westerbeke products, whether from Westerbeke or other suppliers, must not and cannot be relied upon exclusively as the definitive authority on the respective product. It not only makes good sense but is imperative that appropriate representatives of Westerbeke or the supplier in question be consulted to determine the accuracy and currency of the product software being consulted by the customer.

This Parts List covers a family of generators using a carburetor or electronic fuel injection. Most of the parts are common, however be sure to note the proper parts for your application. Also references in the book refer to the 60 Hertz model but are applicable for the corresponding 50 Hertz model as listed in the chart below.

Model	60 Hertz Generator	50 Hertz Generator
Carburetor	4.5 BCGTC	3.75 BCGTC
	7.2 BCGTC	6.0 BCGTC
	9.6 BCGTC	8.0 BCGTC
EFI	4.5 BCGTE	3.75 BCGTE
	7.2 BCGTE	6.0 BCGTE

TABLE OF CONTENTS

PAGE	DESCRIPTION
100	CYLINDER BLOCK
102	BCGTC CYLINDER HEAD - ROCKER COVER
104	BCGTE CYLINDER HEAD - ROCKER COVER
106	CRANKSHAFT - PISTONS
108	VALVES - ROCKER SHAFT - CAMSHAFT
110	TIMING BELT COVER
112	TIMING CASE - LUBE OIL PUMP
114	LUBE OIL FILTER - SUMP - FRONT MOUNTS
116	EXHAUST MANIFOLD - THERMOSTAT
118	COOLING SYSTEM - HEAT EXCHANGER
120	SEA WATER SYSTEM
122	SEA WATER PUMP
124	BCGTC FRESH WATER PUMP - GOVERNOR - BELTS - BELT GUARD
126	BCGTE FRESH WATER PUMP - BELT - BELT GUARD
128	BCGTC GASENSER AND LIFT PUMP
130	DISTRIBUTOR - COIL - SPARKPLUGS
132	DISTRIBUTOR
134	INTAKE MANIFOLD
136	BCGTC AIR INTAKE AND CARBURETOR MOUNTING
138	BCGTC CARBURETOR
140	BCGTE THROTTLE BODY - FUEL REGULATOR - INJECTOR
142	BCGTE FUEL FILTER AND ELECTRONIC PUMP
144	BACK END - GENERATOR - REAR MOUNTS
148	BCGTC GENERATOR CONTROL PANEL
152	BCGTC ELECTRICAL SYSTEM
154	BCGTE GENERATOR CONTROL PANEL
158	BCGTE ELECTRICAL SYSTEM
160	REMOTE CONTROL PANELS
162	SOUND GUARD
164	MISCELLANEOUS

WESTERBEKE 4.5-7.2-9.6 BCGTC/E - CYLINDER BLOCK

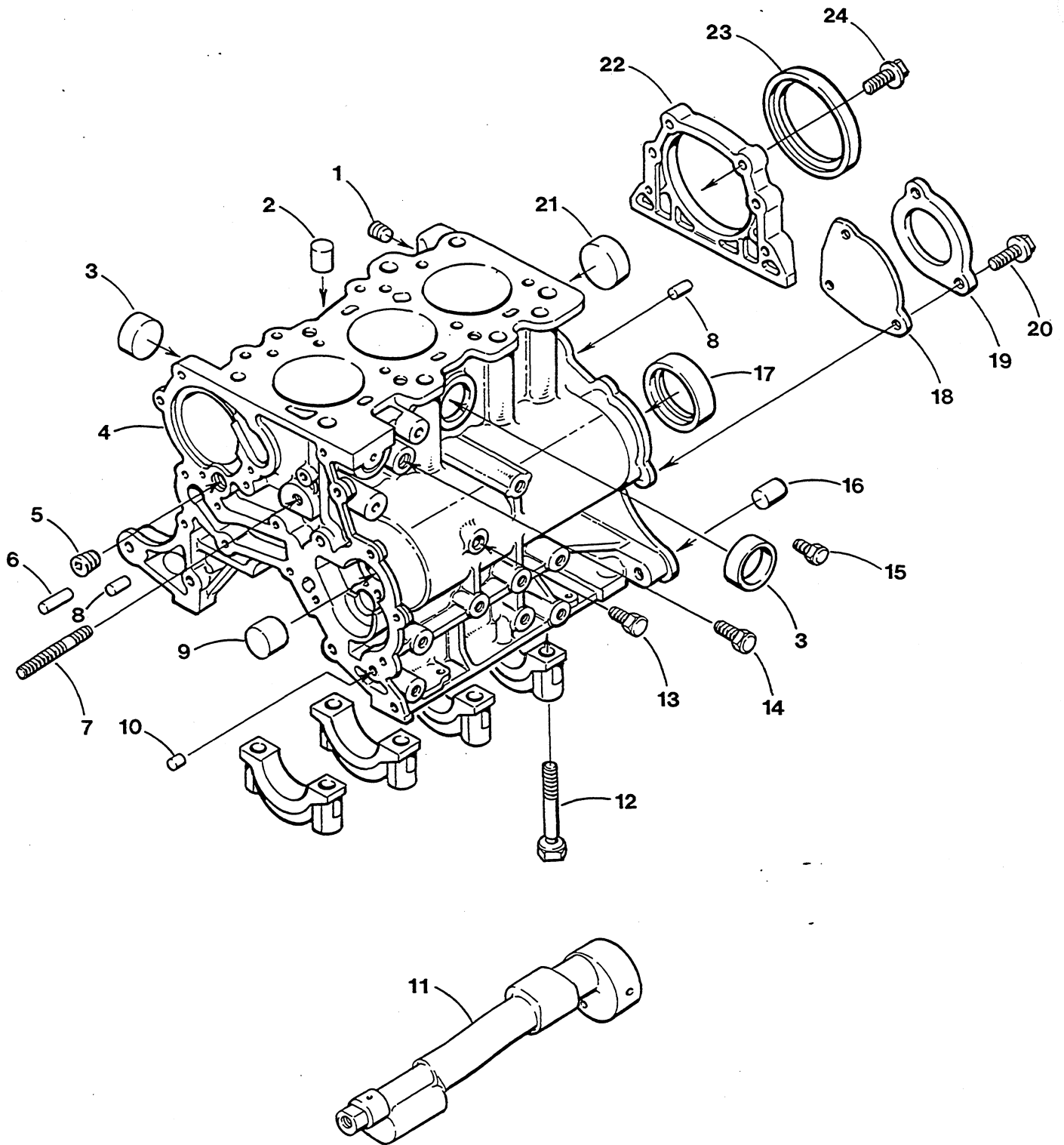

WESTERBEKE 4.5-7.2-9.6 BCGTC/E - CYLINDER BLOCK

REF	PN	NAME	REMARKS	QUAN
1	030711	PLUG	1/8 BSPT DIN 906	1
2	043070	DOWEL	TUBULAR 10 X 16	2
3	024374	PLUG	EXPANSION 30MM DIN 443	3
4	043651	BLOCK	ASSEMBLY	1
5	030712	PLUG	1/4 BSPT DIN 906	1
6	042981	DOWEL	6 X 22	1
7	031282	STUD	M 8 X 45 DIN 939	1
8	041417	DOWEL	6 X 14 DIN 6325	3
9	043002	BEARING	BALANCE SHAFT	1
10	033212	DOWEL	TUBULAR 6 X 9	4
11	043047	SHAFT	BALANCE	1
12	036916	BOLT	MAIN BEARING CAP	8
13	030711	PLUG	1/8 BSPT DIN 906	1
14	013341	PLUG	1/4 NPT HEX HEAD BRASS	1
15	042945	PLUG	1/16	1
16	043070	DOWEL	TUBULAR 10 X 16	2
17	043003	BEARING	BALANCE SHAFT	1
18	043027	GASKET	BALANCE SHAFT COVER	1
19	042970	COVER	BALANCE SHAFT	1
20	033669	CAPSCREW	M 6 X 16 JIS-FLANGE	3
21	024349	PLUG	EXPANSION 35MM DIN 443	1
22	042976	FLANGE	OIL SEAL CRANKSHAFT REAR	1
23	043046	SEAL	OIL	1
24	033669	CAPSCREW	M 6 X 16 JIS-FLANGE	4

WESTERBEKE 4.5-7.2-9.6 BCGTC - CYLINDER HEAD - ROCKER COVER

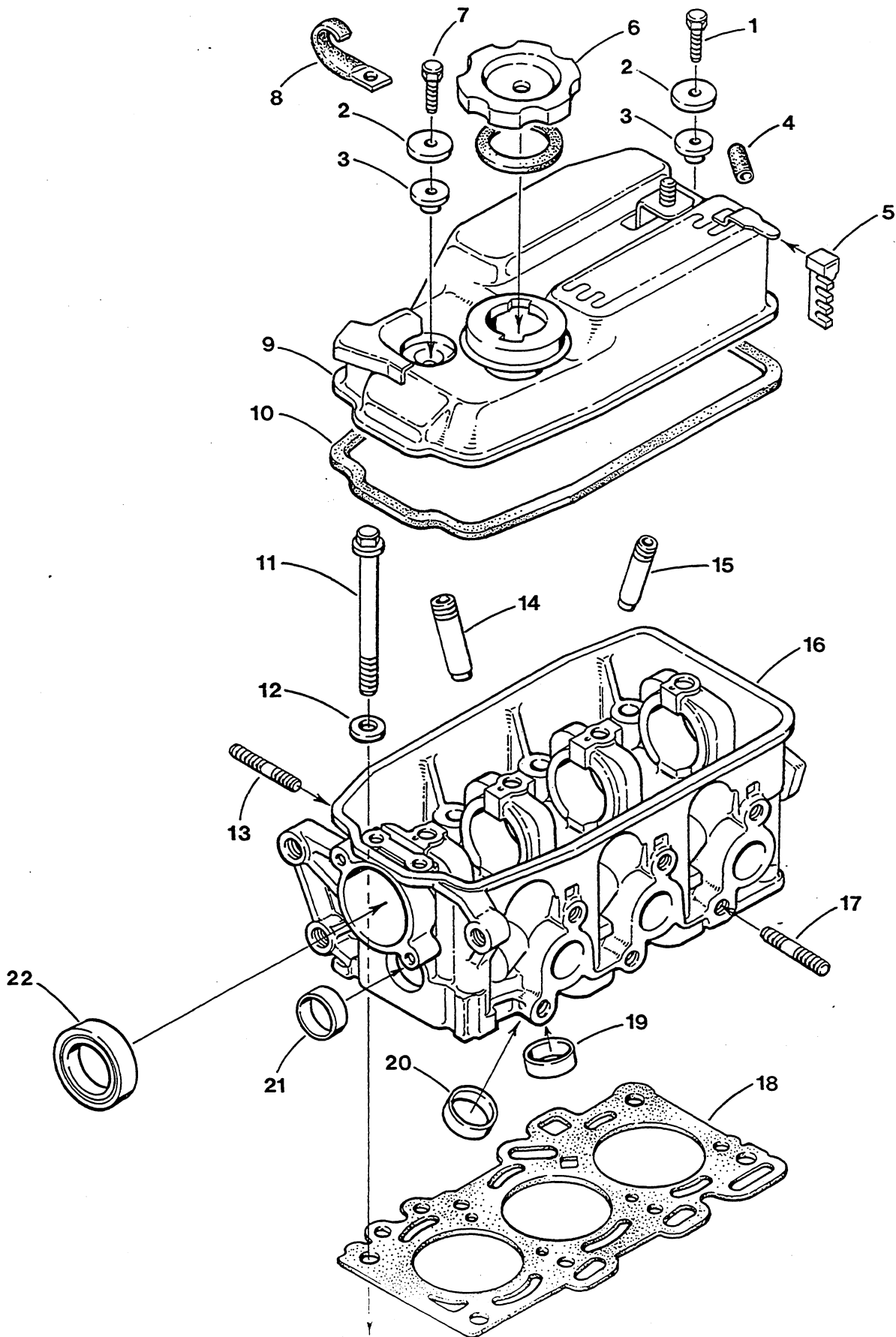

WESTERBEKE 4.5-7.2-9.6 BCGTC - CYLINDER HEAD - ROCKER COVER

REF	PN	NAME	REMARKS	QUAN
1	043063	CAPSCREW	M 6 X 35 JIS W/WASHER	1
2	042975	WASHER	ROCKER COVER	2
3	042960	SEAL	OIL-ROCKER COVER	2
4	042912	CAP	VINYL	1
5	042998	CLAMP	SPARKPLUG WIRES	1
6	030237	CAP	OIL FILL INCLUDING GASKET	1
7	013590	CAPSCREW	M 6 X 30 DIN 933	1
8	038074	CLAMP	FUEL LINE	1
9	042823	COVER	ROCKER	1
10	042688	GASKET	ROCKER COVER	1
11	042968	BOLT	CYLINDER HEAD	8
12	042946	WASHER	CYLINDER HEAD BOLT	8
13	015830	STUD	M 8 X 25 DIN 939	2
14-1	042955	GUIDE	VALVE-INTAKE 0.05	3
14-2	042956	GUIDE	VALVE-INTAKE 0.25	3
14-3	042957	GUIDE	VALVE-INTAKE 0.50	3
15-1	042949	GUIDE	VALVE-EXHAUST 0.05	3
15-2	042950	GUIDE	VALVE-EXHAUST 0.25	3
15-3	042951	GUIDE	VALVE-EXHAUST 0.50	3
16	043028	HEAD	CYLINDER INCLUDING GUIDES & PLUGS	1
17	015830	STUD	M 8 X 25 DIN 939	6
18	043029	GASKET	HEAD	1
19-1	042982	SEAT	VALVE-INTAKE 0.30	3
19-2	042983	SEAT	VALVE-INTAKE 0.60	3
20-1	043000	SEAT	VALVE-EXHAUST 0.30	3
20-2	043001	SEAT	VALVE-EXHAUST 0.60	3
21	024374	PLUG	EXPANSION 30MM DIN 443	1
22	043017	SEAL	OIL	1

WESTERBEKE 4.5-7.2 BCGTE - CYLINDER HEAD - ROCKER COVER

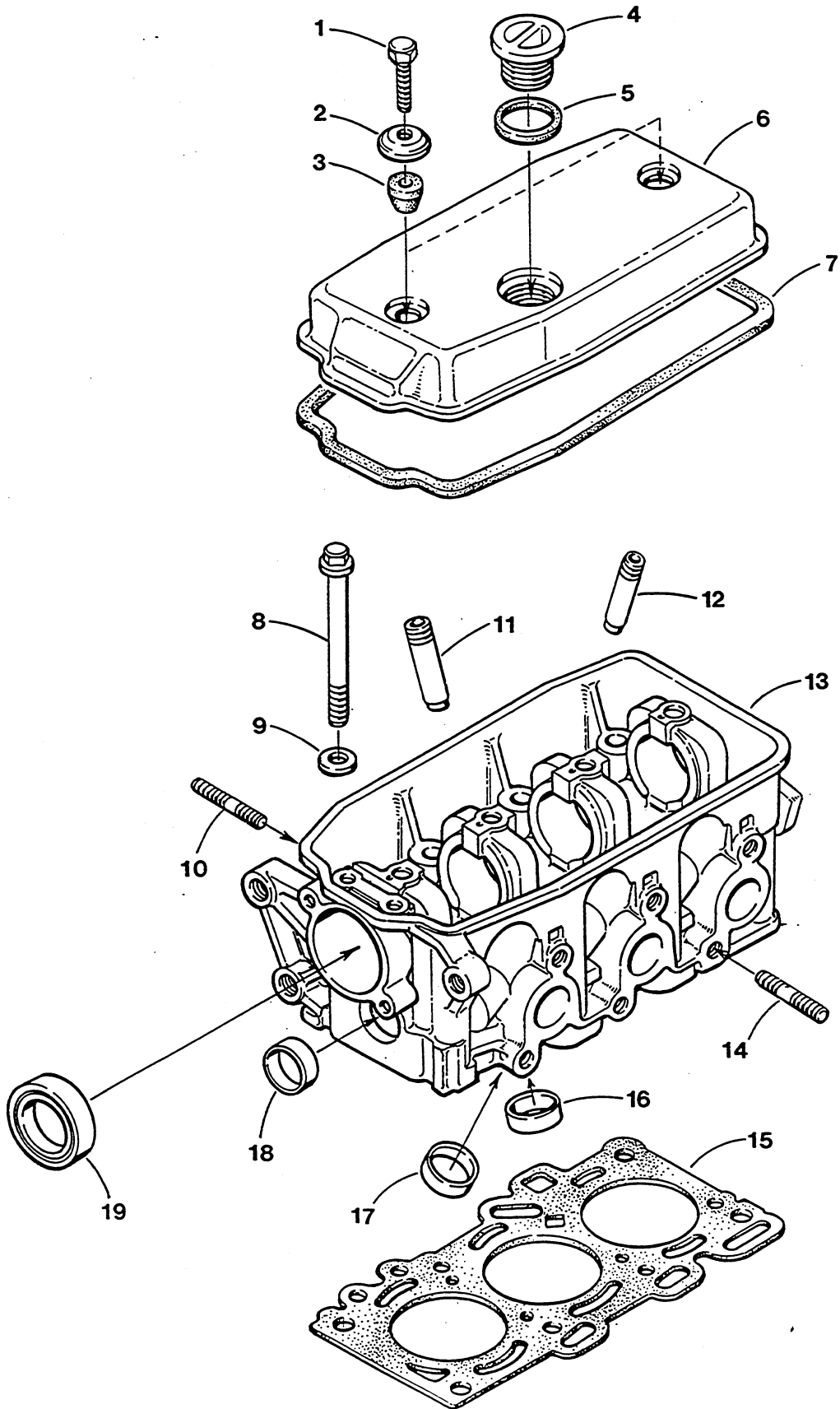

WESTERBEKE 4.5-7.2 BCGTE - CYLINDER HEAD - ROCKER COVER

REF	PN	NAME	REMARKS	QUAN
1	043062	CAPSCREW	M 6 X 25 JIS W/WASHER	2
2	042975	WASHER	ROCKER COVER	2
3	042960	SEAL	OIL-ROCKER COVER	2
4	042271	CAP	OIL FILL	1
5	042431	GASKET	OIL FILL CAP	1
6	043335	COVER	ROCKER	1
7	042688	GASKET	ROCKER COVER	1
8	042968	BOLT	CYLINDER HEAD	8
9	042946	WASHER	CYLINDER HEAD BOLT	8
10	015830	STUD	M 8 X 25 DIN 939	2
11-1	042955	GUIDE	VALVE-INTAKE 0.05	3
11-2	042956	GUIDE	VALVE-INTAKE 0.25	3
11-3	042957	GUIDE	VALVE-INTAKE 0.50	3
12-1	042949	GUIDE	VALVE-EXHAUST 0.05	3
12-2	042950	GUIDE	VALVE-EXHAUST 0.25	3
12-3	042951	GUIDE	VALVE-EXHAUST 0.50	3
13	043028	HEAD	CYLINDER INCLUDING GUIDES & PLUGS	1
14	015830	STUD	M 8 X 25 DIN 939	6
15	043029	GASKET	HEAD	1
16-1	042982	SEAT	VALVE-INTAKE 0.30	3
16-2	042983	SEAT	VALVE-INTAKE 0.60	3
17-1	043000	SEAT	VALVE-EXHAUST 0.30	3
17-2	043001	SEAT	VALVE-EXHAUST 0.60	3
18	024374	PLUG	EXPANSION 30MM DIN 443	1
19	043017	SEAL	OIL	1

WESTERBEKE 4.5-7.2-9.6 BCGTC/E - CRANKSHAFT - PISTONS

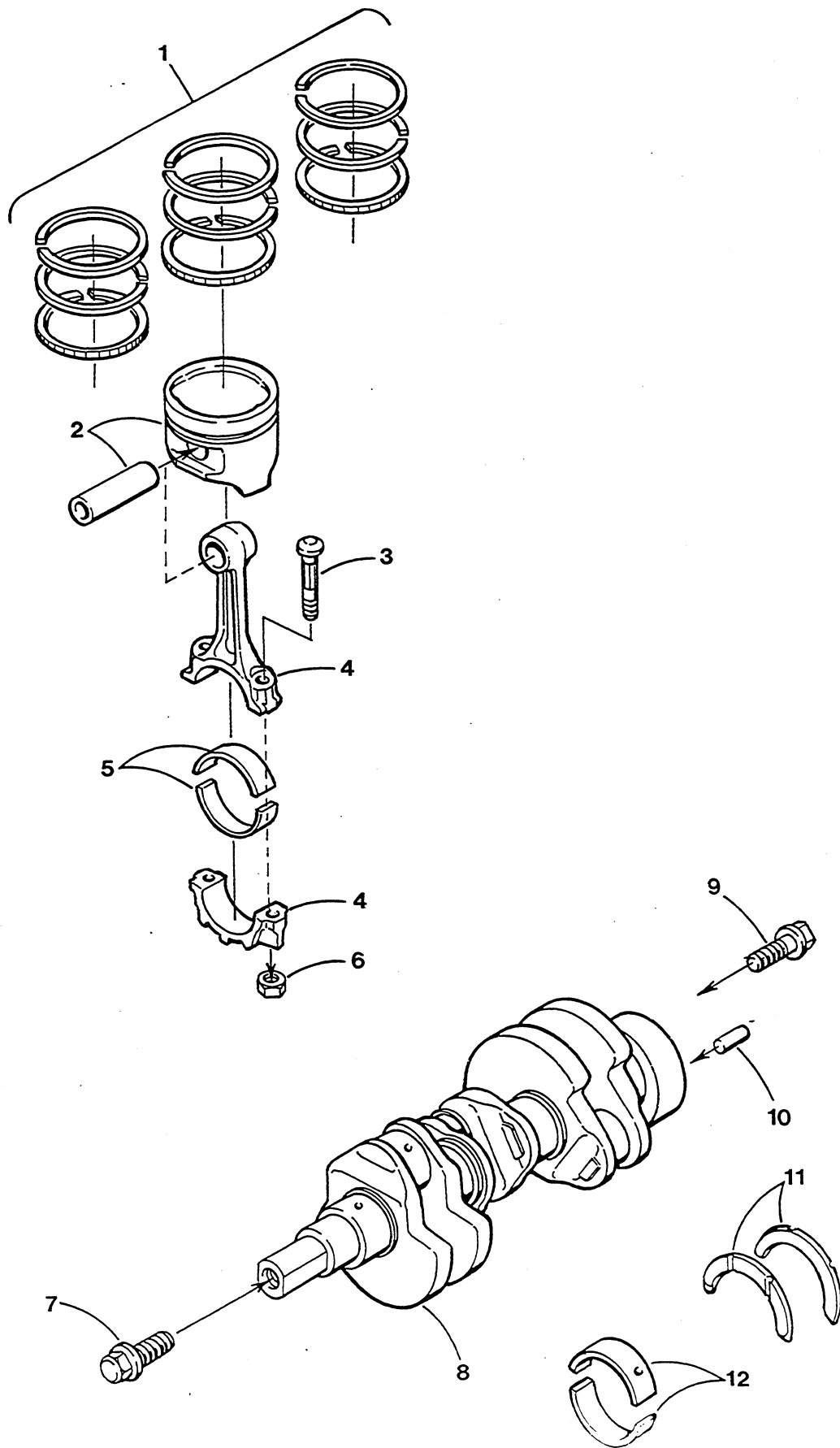

WESTERBEKE 4.5-7.2-9.6 BCGTC/E - CRANKSHAFT - PISTONS

REF	PN	NAME	REMARKS	QUAN
1-1	043014	RING SET	STD-ENGINE SET	1
1-2	043015	RING SET	0.50MM-ENGINE SET	1
1-3	043016	RING SET	1.00MM-ENGINE SET	1
2-1	043010	PISTON	STD INCLUDING PIN	3
2-2	043012	PISTON	0.50MM INCLUDING PIN	3
2-3	043013	PISTON	1.00MM INCLUDING PIN	3
3	043025	BOLT	CONNECTING ROD	6
4	043032	ROD	CONNECTING INCLUDING BOLTS & NUTS	3
5-1	043043	BEARING	CONNECTING ROD BROWN	3
5-2	043044	BEARING	CONNECTING ROD COLORLESS	3
5-3	043045	BEARING	CONNECTING ROD BLUE	3
6	043033	NUT	CONNECTING ROD BOLT	6
7	042980	BOLT	CRANKSHAFT PULLEY	1
8	043034	CRANKSHAFT		1
9	042964	BOLT	FLYWHEEL	5
10	041417	DOWEL	6 X 14 DIN 6325	1
11	043037	WASHER	THRUST SET STD	1
12-1	043038	BEARING	SET MAIN BROWN	4
12-2	043039	BEARING	SET MAIN COLORLESS	4
12-3	043040	BEARING	SET MAIN BLUE	4
12-4	043041	BEARING	SET MAIN YELLOW	4
12-5	043042	BEARING	SET MAIN GREEN	4

WESTERBEKE 4.5-7.2-9.6 BCGTC/E - VALVES - ROCKER SHAFT - CAMSHAFT

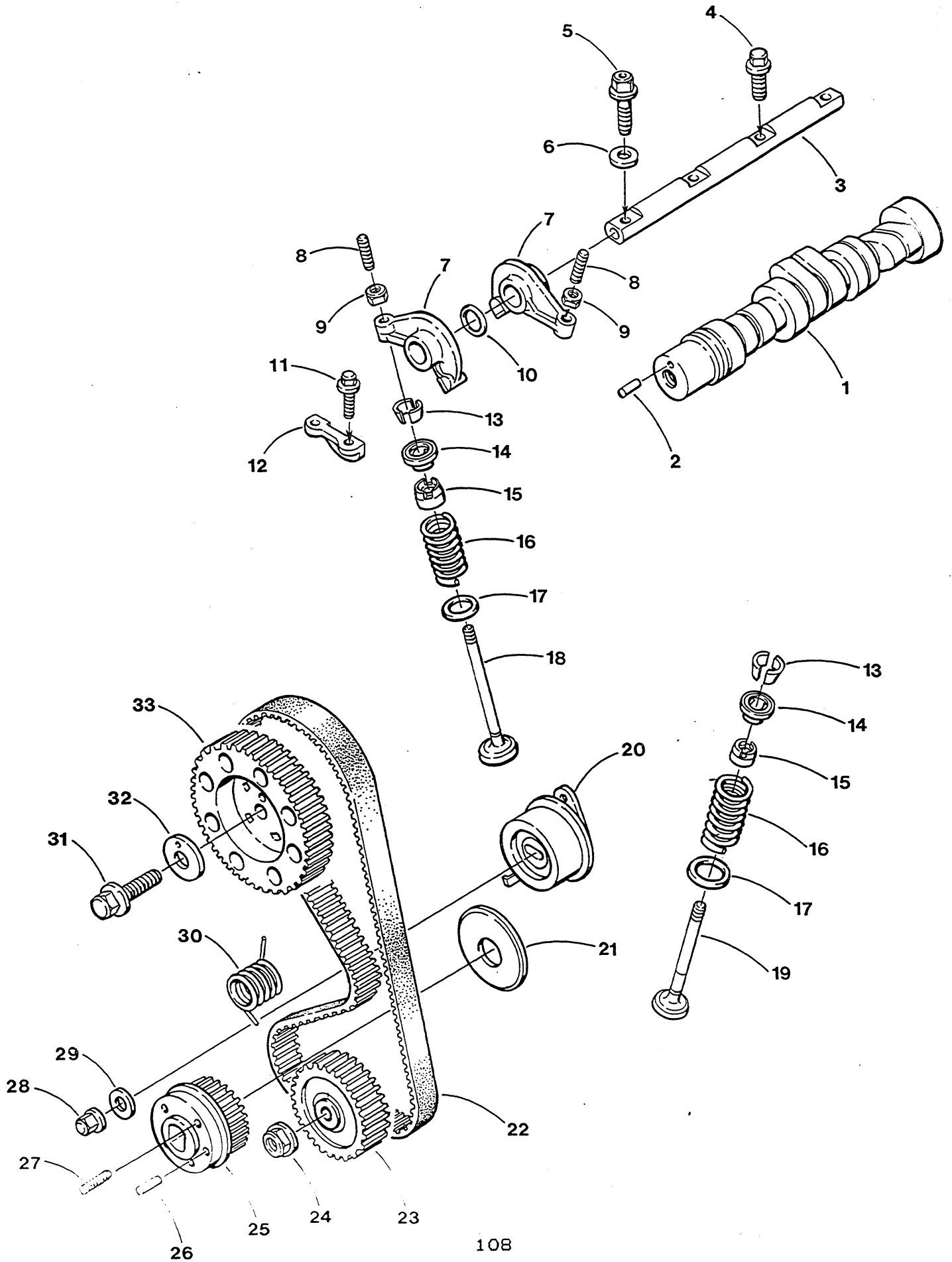

WESTERBEKE 4.5-7.2-9.6 BCGTC/E - VALVES - ROCKER SHAFT - CAMSHAFT

REF	PN	NAME	REMARKS	QUAN
1	043023	CAMSHAFT	INCLUDING REF 2	1
2	043011	PIN		1
3	042994	SHAFT	ROCKER	1
4	042995	BOLT	ROCKER SHAFT INCLUDING WASHER	2
5	042992	BOLT	ROCKER SHAFT FLANGE	2
6	042993	WASHER		2
7	042971	ROCKER		6
8	042977	SCREW	ROCKER ADJUST	6
9	042948	NUT	ROCKER ADJUST	6
10	042961	WASHER	ROCKER SHAFT	3
11	043064	CAPSCREW	M 6 X 14 JIS-FLANGE	2
12	042987	PLATE	CAMSHAFT THRUST	1
13	042952	COLLET	VALVE	12
14	042962	SEAT	VALVE SPRING UPPER	6
15	030242	SEAL	VALVE STEM	6
16	042999	SPRING	VALVE	6
17	042965	SEAT	VALVE SPRING LOWER	6
18	042978	VALVE	INTAKE	3
19	042979	VALVE	EXHAUST	3
20	042990	TENSIONER	TIMING BELT	1
21	042996	FLANGE	CRANKSHAFT TIMING BELT PULLEY	1
22	043036	BELT	TIMING	1
23	043021	PULLEY	OIL PUMP	1
24	042963	NUT	OIL PUMP PULLEY	1
25	043024	PULLEY	CRANKSHAFT TIMING BELT INCL REF 26	1
26	043068	PIN	SPRING	1
27	042894	PIN	CRANKSHAFT PULLEY	4
28	033668	NUT	M 8 JIS-FLANGE	1
29	043067	WASHER	TENSIONER	1
30	043009	SPRING	TENSIONER	1
31	041429	CAPSCREW	M10 X 1.25 X 30 JIS-FLANGE	1
32	042954	WASHER	CAMSHAFT TIMING PULLEY	1
33	043008	PULLEY	CAMSHAFT TIMING BELT	1

WESTERBEKE 4.5-7.2-9.6 BCGTC/E - TIMING BELT COVER

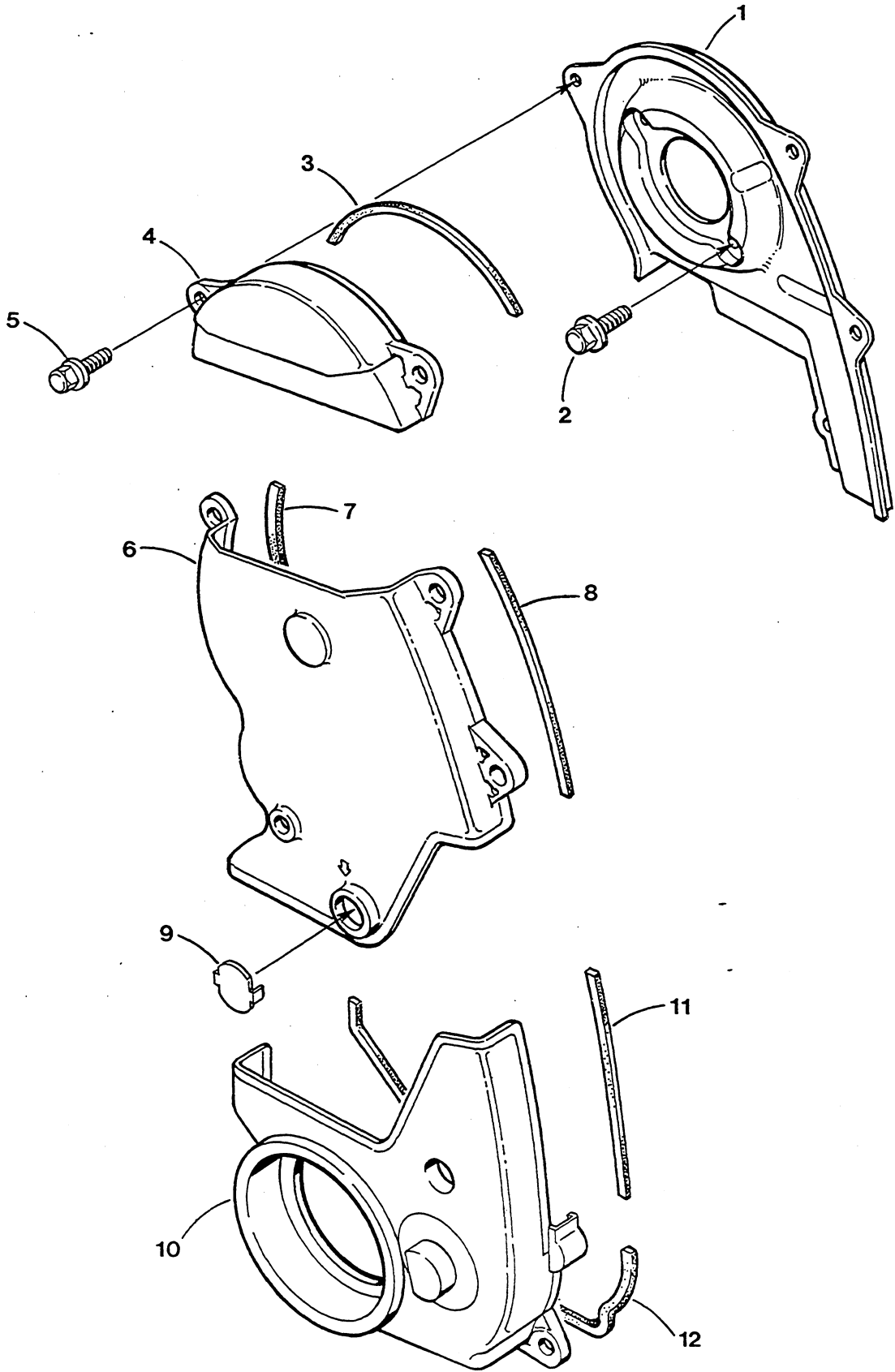

WESTERBEKE 4.5-7.2-9.6 BCGTC/E - TIMING BELT COVER

REF	PN	NAME	REMARKS	QUAN
1	043019	COVER	TIMING BELT TOP REAR	1
2	033669	CAPSCREW	M 6 X 16 JIS-FLANGE	3
3	042985	GASKET	TIMING BELT COVER	1
4	043031	COVER	TIMING BELT TOP INCLUDING REF 3	1
5	033669	CAPSCREW	M 6 X 16 JIS-FLANGE	6
6	043007	COVER	TIMING BELT INCLUDING REF 7-8-9	1
7	042988	GASKET	TIMING BELT COVER	1
8	042985	GASKET	TIMING BELT COVER	1
9	042947	COVER	TIMING BELT ACCESS	1
10	042989	COVER	TIMING BELT LOWER INCLUDING REF 11-12	1
11	042967	GASKET	TIMING BELT	1
12	042966	GASKET	TIMING BELT	1

WESTERBEKE 4.5-7.2-9.6 BCGTC/E - TIMING CASE - LUBE OIL PUMP

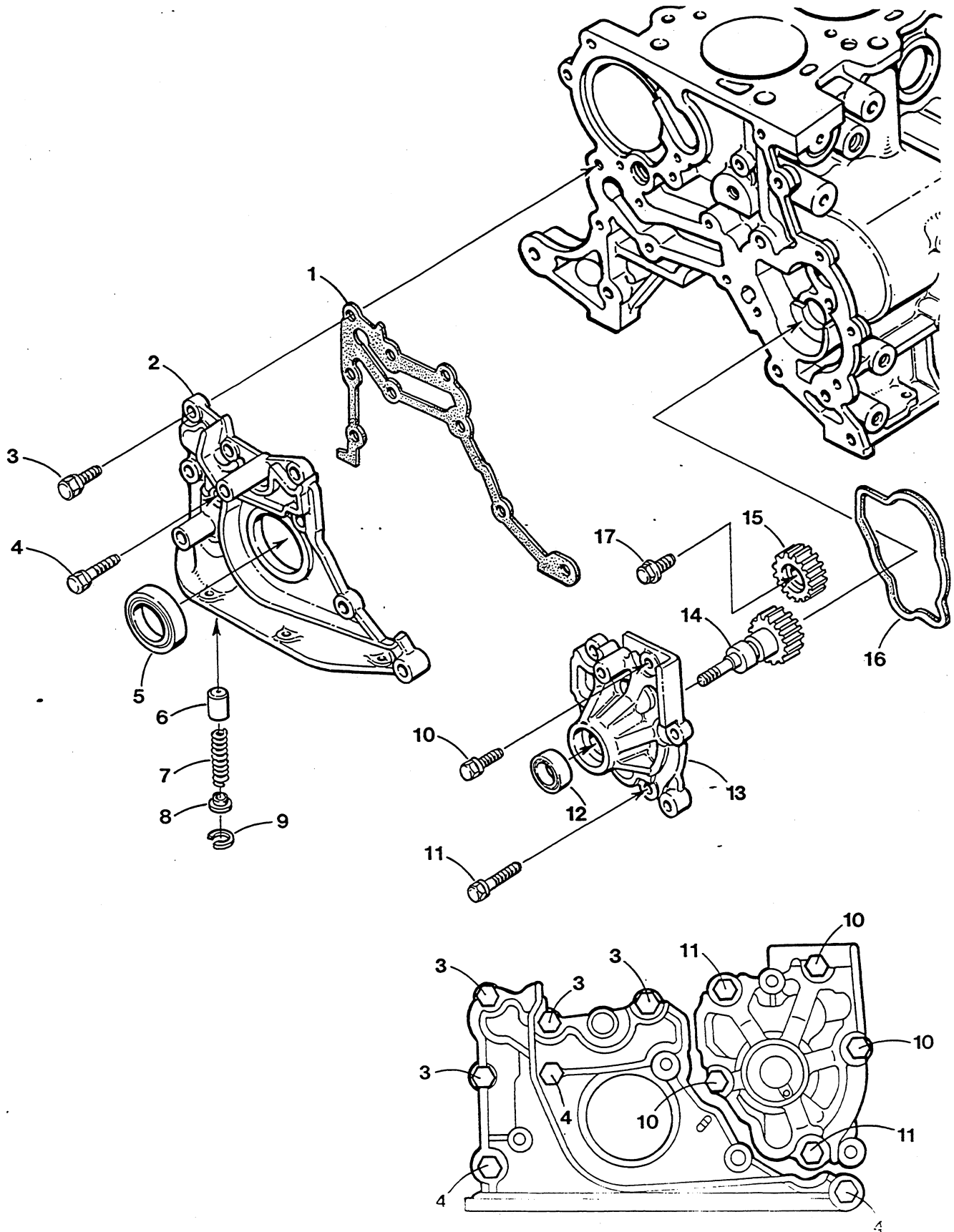

WESTERBEKE 4.5-7.2-9.6 BCGTC/E - TIMING CASE - LUBE OIL PUMP

REF	PN	NAME	REMARKS	QUAN
1	043030	GASKET	TIMING CASE TO BLOCK	1
2	042997	CASE	TIMING INCLUDING REF 5 THRU 9	1
3	043065	CAPSCREW	M 6 X 18 JIS 7 W/LOCKWASHER	6
4	043066	CAPSCREW	M 6 X 30 JIS 7 W/LOCKWASHER	3
5	043048	SEAL	OIL	1
6	042958	PLUNGER	OIL RELIEF VALVE	1
7	042959	SPRING	OIL RELIEF VALVE	1
8	043004	RETAINER	OIL RELIEF VALVE	1
9	043069	RING	RETAINING 12MM INTERNAL	1
10	043065	CAPSCREW	M 6 X 18 JIS 7 W/LOCKWASHER	3
11	043066	CAPSCREW	M 6 X 30 JIS 7 W/LOCKWASHER	2
12	043018	SEAL	OIL PUMP	1
13	043022	PUMP	OIL INCL REF 12 THRU 15	1
14	042972	GEAR	OIL PUMP DRIVE	1
15	042973	GEAR	OIL PUMP	1
16	042969	GASKET	OIL PUMP	1
17	042953	BOLT	OIL PUMP GEAR	1

WESTERBEKE 4.5-7.2-9.6 BCGTC/E - LUBE OIL FILTER - SUMP - FRONT MOUNTS

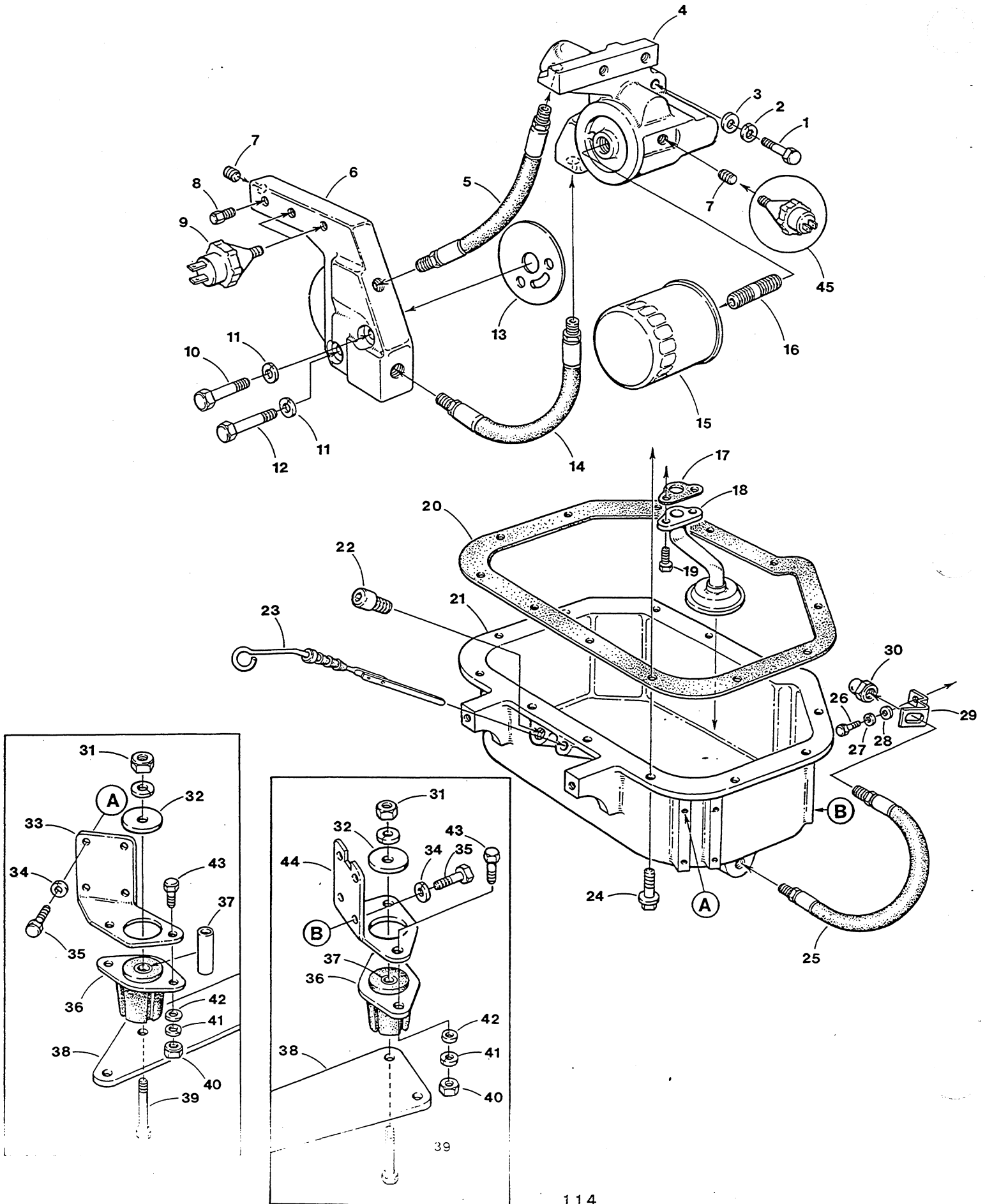

WESTERBEKE 4.5-7.2-9.6 BCGTC/E - LUBE OIL FILTER - SUMP - FRONT MOUNTS

REF	PN	NAME	REMARKS	QUAN
1	298616	CAPSCREW	M10 X 1.25 X 50 DIN 961	2
2	019262	LOCKWASHER	M10 DIN 127	2
3	031789	WASHER	M10 DIN 125	2
4-1	042414	BRACKET	OIL FILTER-GOVERNOR BCGTC	1
4-2	043417	BRACKET	OIL FILTER BCGTE	1
5	042611	HOSE	OIL	1
6	042277	ADAPTER	LUBE OIL TO BLOCK	1
7-1	024601	PLUG	1/4 NPT SOCKET BCGTC	1
7-2	024601	PLUG	1/4 NPT SOCKET BCGTE	2
8	019369	PLUG	1/8 NPT HEX HEAD BRASS	2
9	037323	SWITCH	OIL PRESSURE	1
10	013619	CAPSCREW	M 8 X 30 DIN 933	1
11	031786	LOCKWASHER	M 8 DIN 127	2
12	021558	CAPSCREW	M 8 X 35 DIN 933	1
13	041323	GASKET	OIL ADAPTER TO BLOCK	1
14	042612	HOSE	OIL	1
15	036918	FILTER	OIL	1
16	034663	NIPPLE	OIL FILTER	1
17	042141	GASKET	OIL PICKUP	1
18	043481	STRAINER	OIL PICKUP	1
19-1	017196	CAPSCREW	M 8 X 20 DIN 933	2
19-2	031786	LOCKWASHER	M 8 DIN 127	2
20	042020	GASKET	SUMP	1
21	042110	SUMP	OIL	1
22	043419	PLUG	1/2 UNF SOCKET INCLUDING O-RING	1
23	042273	DIPSTICK		1
24	042891	CAPSCREW	M 6 X 20 W/WASHER-LOCKWASHER	13
25	042811	HOSE	SUMP DRAIN	1
26	013630	CAPSCREW	M 8 X 25 DIN 933	1
27	031786	LOCKWASHER	M 8 DIN 127	1
28	031787	WASHER	M 8 DIN 125	1
29	024922	BRACKET	SUMP DRAIN HOSE	1
30	024905	CAP	SUMP DRAIN HOSE	1
31	043139	NUT	M10 DIN 934 304SS	2
32	042303	WASHER	ISOLATOR REBOUND	2
33	042035	MOUNT	FRONT RIGHT	1
34	031783	LOCKWASHER	M 6 DIN 127	8
35	017012	CAPSCREW	M 6 X 16 DIN 933	8
36	042810	ISOLATOR		2
37	042302	SPACER		2
38	042293	PLATE	FRONT MOUNT	1
39	043257	CAPSCREW	M10 X 65 DIN 7991 304SS	2
40	015812	NUT	M 6 DIN 934	4
41	031783	LOCKWASHER	M 6 DIN 127	4
42	031784	WASHER	M 6 DIN 125	4
43	017012	CAPSCREW	M 6 X 16 DIN 933	4
44	042034	MOUNT	FRONT LEFT	1
45	043242	SWITCH	OIL TEMPERATURE BCGTC	1

WESTERBEKE 4.5-7.2-9.6 BCGTC/E - EXHAUST MANIFOLD - THERMOSTAT

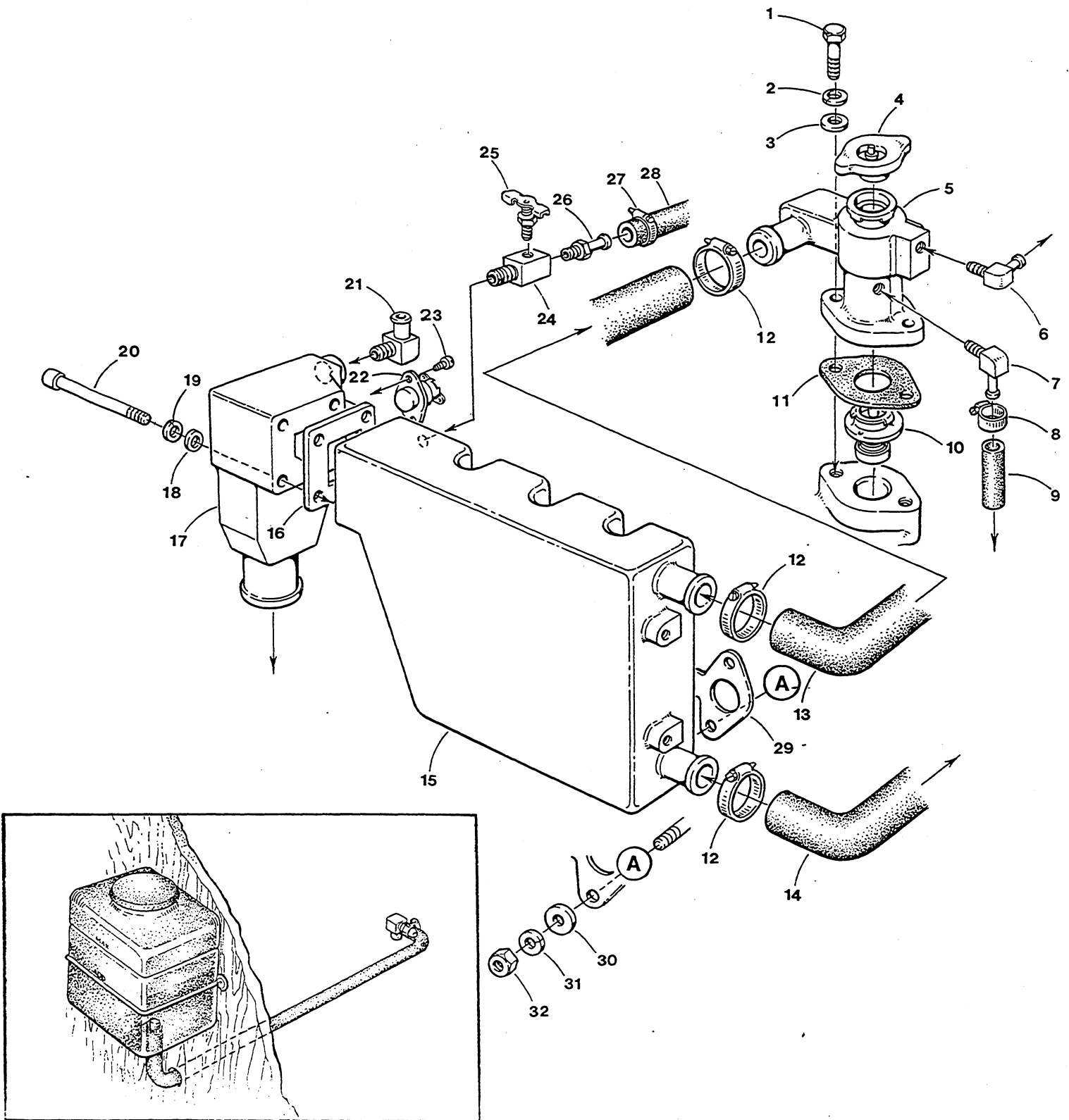

WESTERBEKE 4.5-7.2-9.6 BCGTC/E - EXHAUST MANIFOLD - THERMOSTAT

REF	PN	NAME	REMARKS	QUAN
1-1	020628	CAPSCREW	M 6 X 25 DIN 933 BCGTC	2
1-2	018804	CAPSCREW	M 6 X 20 DIN 933 BCGTE	2
2	031783	LOCKWASHER	M 6 DIN 127	2
3	031784	WASHER	M 6 DIN 125	2
4	024306	CAP	PRESSURE	1
5	042228	HOUSING	THERMOSTAT	1
6	024907	ELBOW	COOLANT RECOVERY TANK CONNECTION	1
7	042616	ELBOW	MALE 1/8 NPT TO 1/4" HOSE	1
8	040384	CLAMP	HOSE	1
9	036869	HOSE	3/16" ID - INCHES REQUIRED	2
10	039378	THERMOSTAT		1
11	042260	GASKET	THERMOSTAT	1
12	011405	CLAMP	HOSE 16	3
13	042122	HOSE	THERMOSTAT TO MANIFOLD	1
14	042124	HOSE	MANIFOLD TO EXCHANGER	1
15	044391	MANIFOLD	EXHAUST	1
16	042304	GASKET	MANIFOLD TO EXHAUST ELBOW	1
17	042724	ELBOW	INJECTED EXHAUST	1
18	031784	WASHER	M 6 DIN 125	4
19	031783	LOCKWASHER	M 6 DIN 127	4
20	043291	CAPSCREW	M 6 X 90 DIN 931	4
21	042258	ELBOW	3/8 NPT TO 3/4" HOSE	1
22	032923	SWITCH	EXHAUST TEMPERATURE	1
23	035711	SCREW	6-32 X 1/4 TAPPING	2
24	016692	TEE	1/8 NPT STREET BRASS	1
25	011471	PETCOCK	1/8 NPT	1
26	043905	CONNECTOR	MALE 1/8 NPT TO 1/4" HOSE	1
27	040384	CLAMP	HOSE	1
28	036869	HOSE	3/16" ID - INCHES REQUIRED	13
29	042252	GASKET	MANIFOLD TO HEAD	1
30	031787	WASHER	M 8 DIN 125	6
31	031786	LOCKWASHER	M 8 DIN 127	6
32	018242	NUT	M 8 DIN 934	6
33	024977	KIT	COOLANT RECOVERY TANK	1

WESTERBEKE 4.5-7.2-9.6 BCGTC/E - COOLING SYSTEM - HEAT EXCHANGER

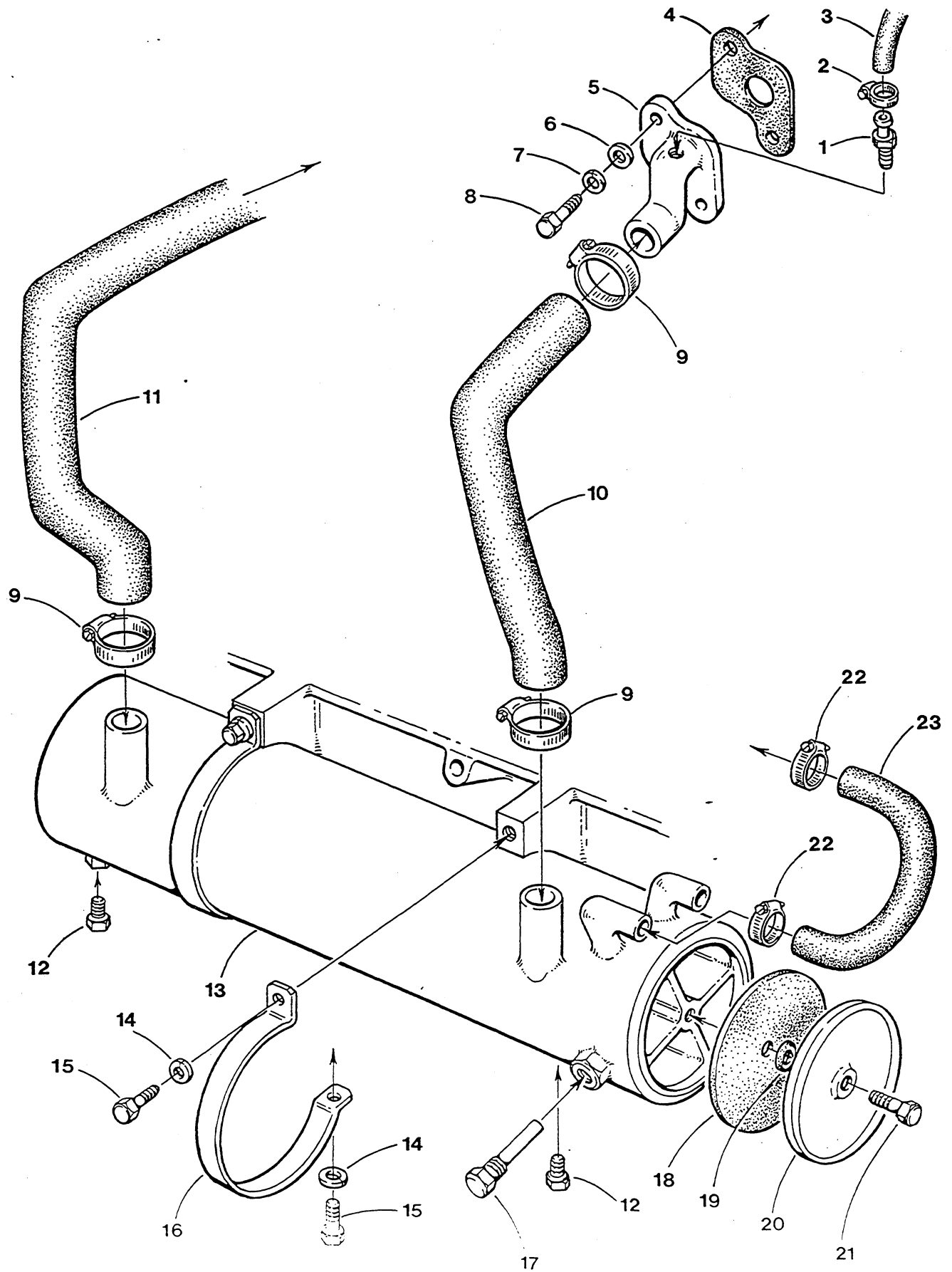

WESTERBEKE 4.5-7.2-9.6 BCGTC/E - COOLING SYSTEM - HEAT EXCHANGER

REF	PN	NAME	REMARKS	QUAN
1	043905	CONNECTOR		1
2	040384	CLAMP	HOSE	1
3	036869	HOSE	3/16" ID - INCHES REQUIRED	13
4	042147	GASKET		1
5	042079	ELBOW	WATER INLET	1
6	031787	WASHER	M 8 DIN 125	2
7	031786	LOCKWASHER	M 8 DIN 127	2
8	013630	CAPSCREW	M 8 X 25 DIN 933	2
9	011405	CLAMP	HOSE 16	3
10	042193	HOSE	EXCHANGER TO BLOCK	1
11	042124	HOSE	MANIFOLD TO EXCHANGER	1
12	019369	PLUG	1/8 NPT HEX HEAD BRASS	2
13	043282	EXCHANGER	HEAT	1
14	031783	LOCKWASHER	M 6 DIN 127	4
15	017012	CAPSCREW	M 6 X 16 DIN 933	4
16	042264	CLAMP	EXCHANGER	2
17	011885	ZINC		1
18	022851	GASKET	EXCHANGER END COVER	1
19	019321	O-RING	EXCHANGER END COVER	1
20	022850	COVER	EXCHANGER END	1
21	022852	CAPSCREW	3/8NC X 3/4 SS	1
22	011386	CLAMP	HOSE 12	2
23	036654	HOSE	SEA WATER PUMP TO EXCHANGER BCGTE	1

WESTERBEKE 4.5-7.2-9.6 BCGTC/E - SEA WATER SYSTEM

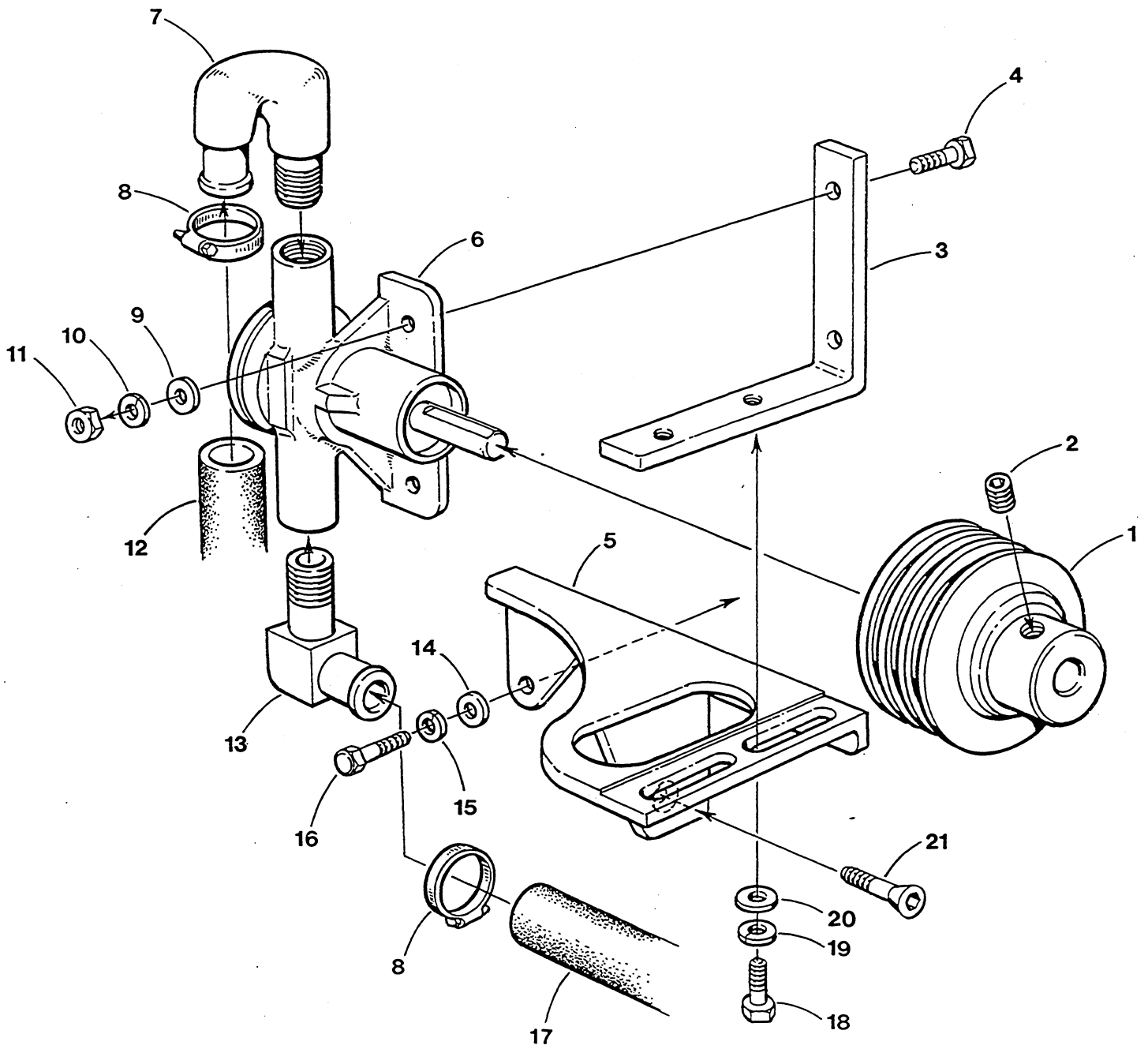

WESTERBEKE 4.5-7.2-9.6 BCGTC/E - SEA WATER SYSTEM

REF	PN	NAME	REMARKS	QUAN
1	042774	PULLEY	SEA WATER PUMP	1
2	011357	SETSCREW	PULLEY	1
3	042023	BRACKET	SEA WATER PUMP ADJUST	1
4	018804	CAPSCREW	M 6 X 20 DIN 933	2
5	042281	BRACKET	SEA WATER PUMP	1
6	032617	PUMP	SEA WATER	1
7	042126	ELBOW	3/8 NPT TO 3/4" HOSE 180	1
8	011386	CLAMP	HOSE 12	2
9	031784	WASHER	M 6 DIN 125	2
10	031783	LOCKWASHER	M 6 DIN 127	2
11	015812	NUT	M 6 DIN 934	2
12		HOSE	CUSTOMER SUPPLIED	1
13	042257	ELBOW	3/8 NPT TO 3/8" HOSE	1
14	031787	WASHER	M 8 DIN 125	1
15	031786	LOCKWASHER	M 8 DIN 127	1
16	013630	CAPSCREW	M 8 X 25 DIN 933	1
17-1	042934	HOSE	GASDENSER TO EXCHANGER BCGTC	1
17-2	036654	HOSE	SEA WATER PUMP TO EXCHANGER	1
18	018804	CAPSCREW	M 6 X 20 DIN 933	2
19	031783	LOCKWASHER	M 6 DIN 127	2
20	031784	WASHER	M 6 DIN 125	2
21	200442	CAPSCREW	M10 X 1.25 X 20 DIN 7991	1

WESTERBEKE 4.5-7.2-9.6 BCGTC/E - SEA WATER PUMP

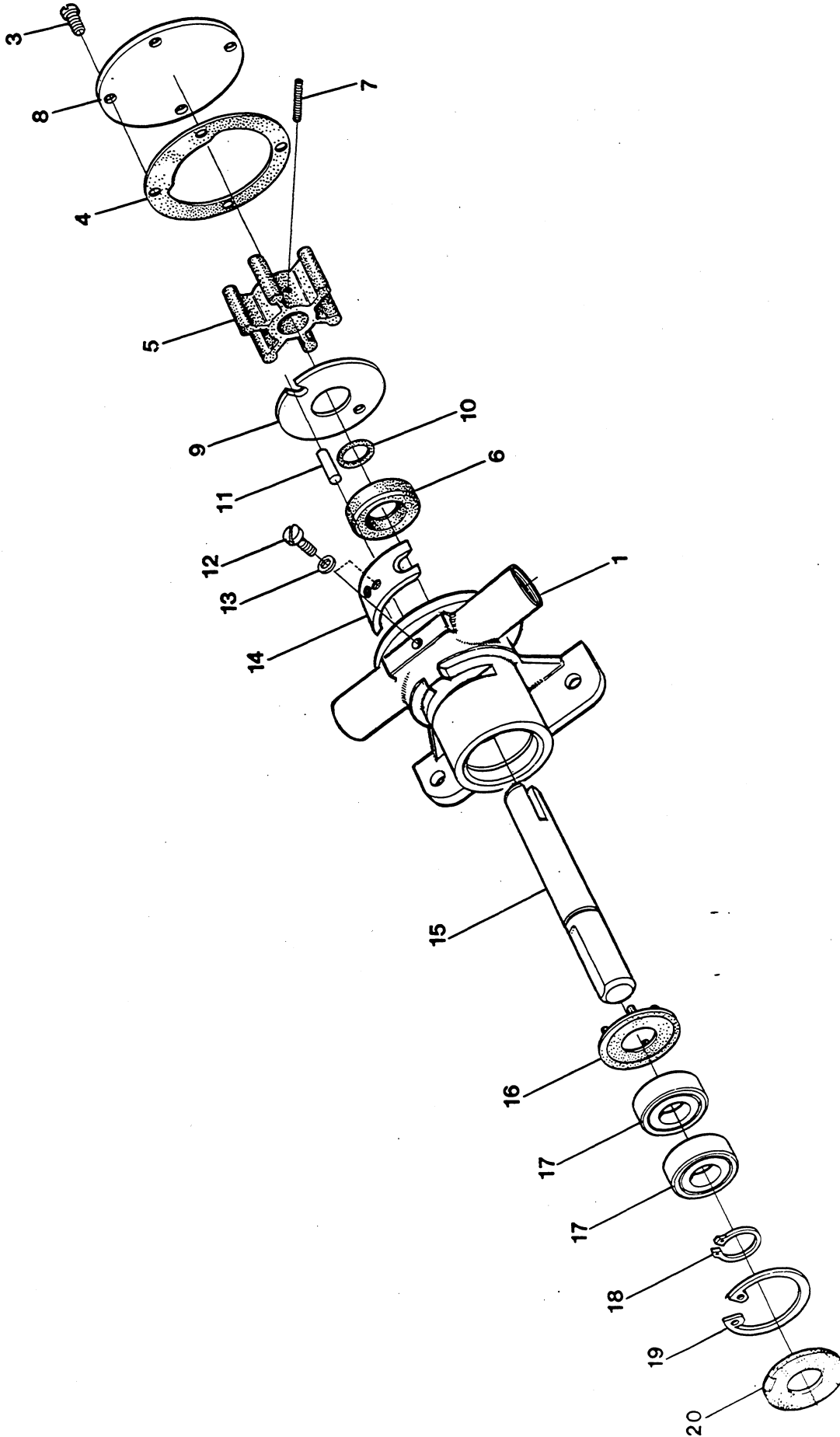

WESTERBEKE 4.5-7.2-9.6 BCGTC/E - SEA WATER PUMP

REF	PN	NAME	REMARKS	QUAN
1	032617	PUMP	SEA WATER	1
2	032620	KIT	IMPELLER INCL REF 3 THRU 7	1
3		SCREW	COVER-SEE KIT REF 2	4
4	033032	GASKET	IMPELLER COVER	1
5		IMPELLER	SEE KIT REF 2	1
6		SEAL	SEE KIT REF 2	1
7		SCREW	IMPELLER-SEE KIT REF 2	1
8	032625	COVER	IMPELLER	1
9	033036	PLATE	WEAR	1
10	033041	O-RING		1
11	302575	DOWEL		1
12	033038	SCREW	CAM	1
13	033037	WASHER		1
14	033031	CAM		1
15	033035	SHAFT		1
16	033034	COVER	BEARING-INNER	1
17	033042	BEARING		2
18	033045	RING	RETAINING	1
19	033044	RING	RETAINING	1
20	033033	COVER	BEARING-OUTER	1
21	040455	KIT	PUMP MAJOR REBUILD	1

4.5-7.2-9.6 BCGTC - FRESH WATER PUMP - GOVERNOR - BELTS - BELT GUARD

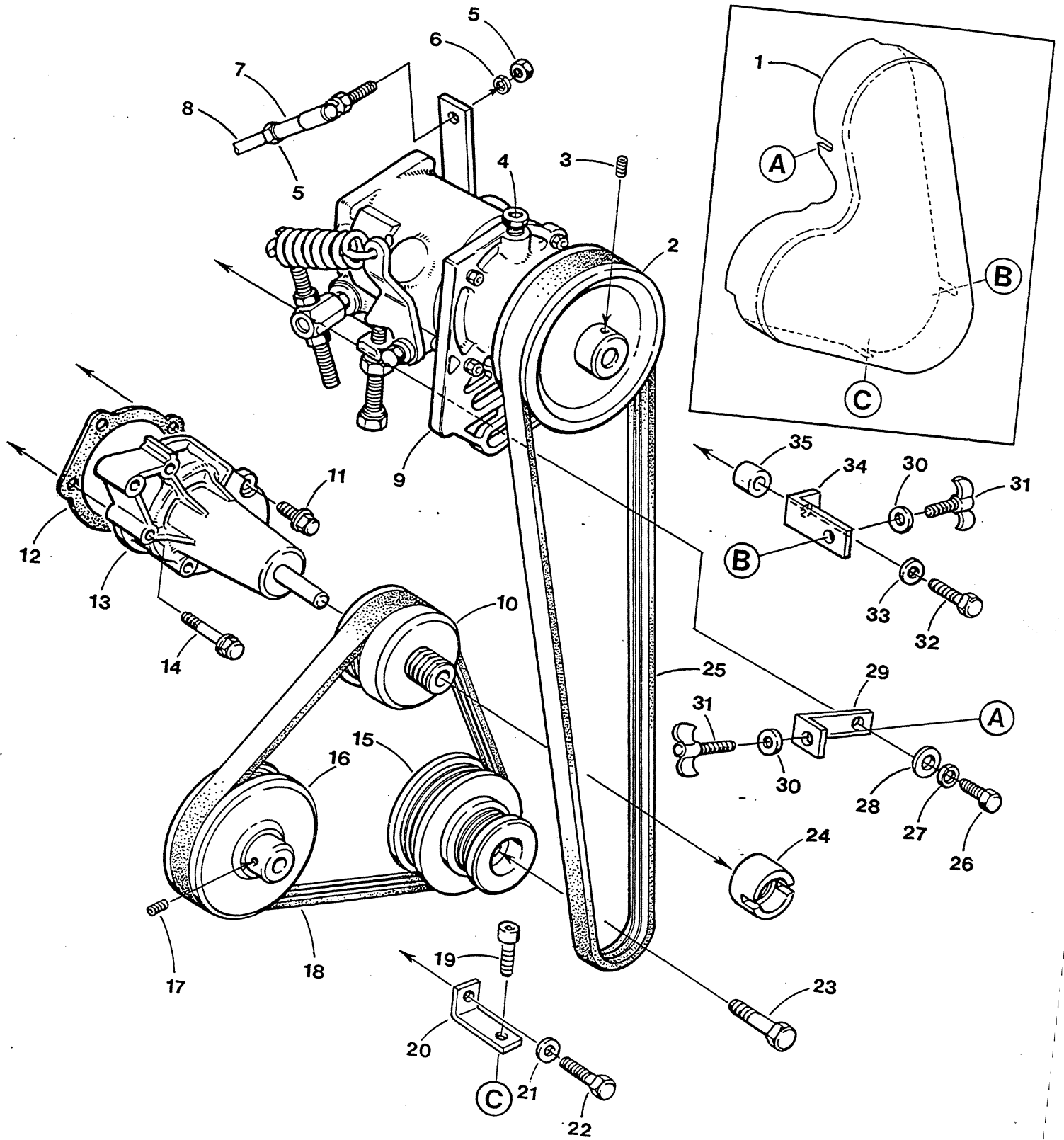

4.5-7.2-9.6 BCGTC - FRESH WATER PUMP - GOVERNOR - BELTS - BELT GUARD

REF	PN	NAME	REMARKS	QUAN
1	042694	GUARD	BELT	1
2	042771	PULLEY	GOVERNOR	1
3	043585	PIN	SPIRAL 3/16 X 1-1/4	1
4	042896	PLUG	1/8 NPT SOCKET BRASS	1
5	031847	NUT	10-32 HEX SS	3
6	031849	LOCKWASHER	10 SS	1
7	019364	BALLJOINT		1
8	036423	ROD	THREADED	1
9	042822	GOVERNOR		1
10	042797	PULLEY	FRESH WATER PUMP	1
11	043065	CAPSCREW	M 6 X 18 JIS 7 W/LOCKWASHER	2
12	043005	GASKET	FRESH WATER PUMP	1
13	043809	PUMP	FRESH WATER INCLUDING REF 10-12-13-24	1
14	301590	CAPSCREW	M 6 X 35 JIS 7 W/LOCKWASHER	3
15	042795	PULLEY	CRANKSHAFT	1
16	042774	PULLEY	SEA WATER PUMP	1
17	011357	SETSCREW	PULLEY	1
18	046440	BELT	WATER PUMPS	1
19	031873	SCREW	10-32 X 5/8 SS BH	1
20	042830	BRACKET	BELT GUARD	1
21	031783	LOCKWASHER	M 6 DIN 127	1
22	017012	CAPSCREW	M 6 X 16 DIN 933	1
23	042980	BOLT	CRANKSHAFT PULLEY	1
24	042800	NUT	FRESH WATER PUMP PULLEY	1
25	042798	BELT	GOVERNOR	1
26	034589	CAPSCREW	M10 X 30 DIN 933	2
27	019262	LOCKWASHER	M10 DIN 127	2
28	031789	WASHER	M10 DIN 125	2
29	042831	BRACKET	BELT GUARD	1
30	033372	WASHER	FLAT	2
31	033228	WINGSCREW	10-32 X 1/2	2
32	013590	CAPSCREW	M 6 X 30 DIN 933	1
33	031783	LOCKWASHER	M 6 DIN 127	1
34	042578	BRACKET	BELT GUARD	1
35	021722	SPACER		1

WESTERBEKE 4.5-7.2 BCGTE - FRESH WATER PUMP - BELT - BELT GUARD

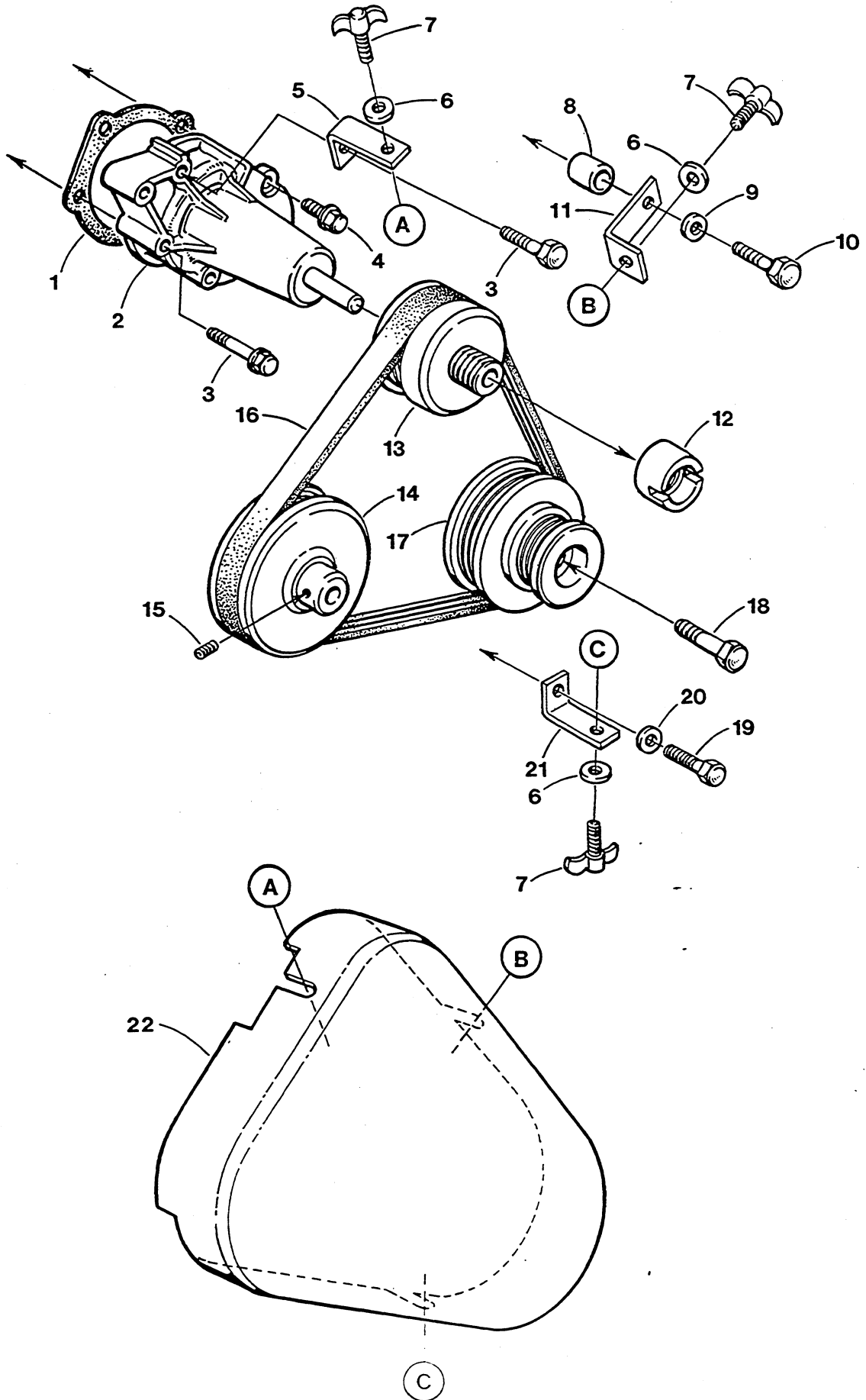

WESTERBEKE 4.5-7.2 BCGTE - FRESH WATER PUMP - BELT - BELT GUARD

REF	PN	NAME	REMARKS	QUAN
1	043005	GASKET	FRESH WATER PUMP	1
2	043809	PUMP	FRESH WATER INCLUDING REF 1-2-12-13	1
3	301590	CAPSCREW	M 6 X 35 JIS 7 W/LOCKWASHER	3
4	043065	CAPSCREW	M 6 X 18 JIS 7 W/LOCKWASHER	2
5	042577	BRACKET	BELT GUARD	1
6	033372	WASHER	FLAT	3
7	033228	WINGSCREW	10-32 X 1/2	3
8	021722	SPACER		1
9	031783	LOCKWASHER	M 6 DIN 127	1
10	013590	CAPSCREW	M 6 X 30 DIN 933	1
11	042578	BRACKET	BELT GUARD	1
12	042800	NUT	FRESH WATER PUMP PULLEY	1
13	042797	PULLEY	FRESH WATER PUMP	1
14	042774	PULLEY	SEA WATER PUMP	1
15	011357	SETSCREW	PULLEY	1
16	046440	BELT		1
17	042795	PULLEY	CRANKSHAFT	1
18	042980	BOLT	CRANKSHAFT PULLEY	1
19	017012	CAPSCREW	M 6 X 16 DIN 933	1
20	031783	LOCKWASHER	M 6 DIN 127	1
21	042579	BRACKET	BELT GUARD	1
22	042384	GUARD	BELT	1

WESTERBEKE 4.5-7.2-9.6 BCGTC - GASDENSER AND LIFT PUMP

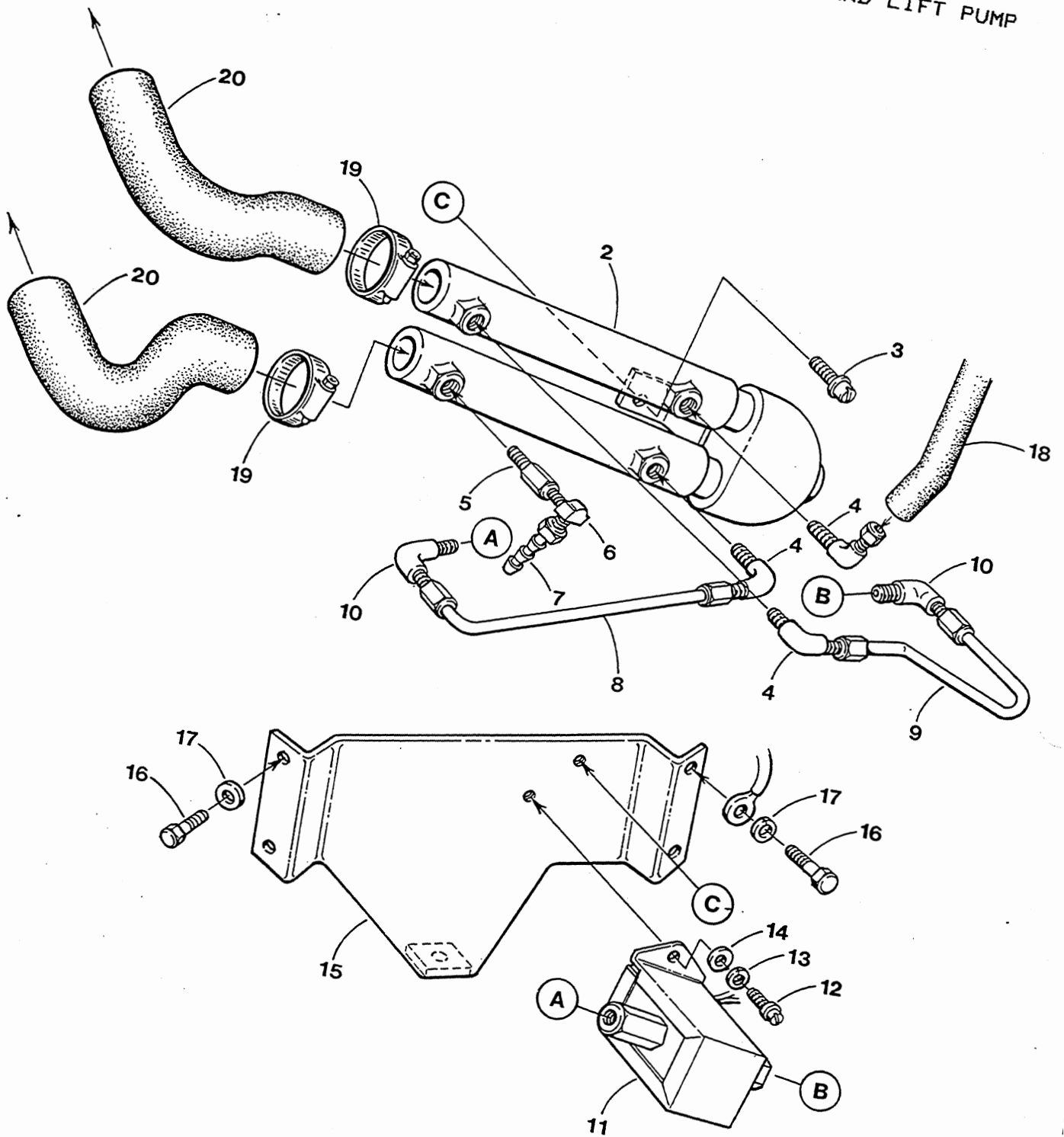

WESTERBEKE 4.5-7.2-9.6 BCGTC - GASDENSER AND LIFT PUMP

REF	PN	NAME	REMARKS	QUAN
1	042865	GASDENSER	LIFT PUMP ASSEMBLY INCL REF 2 THRU 15	1
2	043125	GASDENSER		1
3	043345	SCREW	M 5 X 10 FLANGED	1
4-1	013345	ELBOW	MALE 1/8 NPT TO 3/16 COMPRESSION	3
4-2	013344	NUT	3/16 COMPRESSION	AR
4-3	013343	FERRULE	3/16 COMPRESSION	AR
5	013339	ADAPTER	1/8 NPT MALE-FEMALE	1
6	013340	ELBOW	1/8 NPT STREET 90 BRASS	1
7	021448	CONNECTOR	MALE 1/8 NPT TO 1/4" HOSE	1
8-1	043114	LINE	GASDENSER TO LIFT PUMP - NLA	1
8-2	044756	LINE	GASDENSER TO LIFT PUMP	1
9-1	043115	LINE	LIFT PUMP TO GASDENSER NLA	1
9-2	044757	LINE	LIFT PUMP TO GASDENSER	1
9-3		NOTE:	OLD LINES CROSSED-NEW ARE PARALLEL-SO	
9-4			BOTH LINES MUST BE CHANGED TO NEW	
10-1	013345	ELBOW	MALE 1/8 NPT TO 3/16 COMPRESSION	2
10-2	013344	NUT	3/16 COMPRESSION	AR
10-3	013343	FERRULE	3/16 COMPRESSION	AR
11	043124	PUMP	FUEL LIFT 12 VDC INCLUDING REF 10	1
12	031918	SCREW	M 5 X 10 DIN 84A	2
13	031780	LOCKWASHER	M 5 DIN 127	2
14	031781	WASHER	M 5 DIN 125	2
15	042737	BRACKET	LIFT PUMP AND GASDENSER	1
16	017012	CAPSCREW	M 6 X 16 DIN 933	4
17	031783	LOCKWASHER	M 6 DIN 127	4
18	042825	LINE	GASDENSER TO CARBURETOR-INSULATED	1
19	011386	CLAMP	HOSE 12	4
20	042934	HOSE	SEA PUMP TO GASDENSER TO EXCHANGER	2

WESTERBEKE 4.5-7.2-9.6 BCGTC/E - DISTRIBUTOR - COIL - SPARKPLUGS

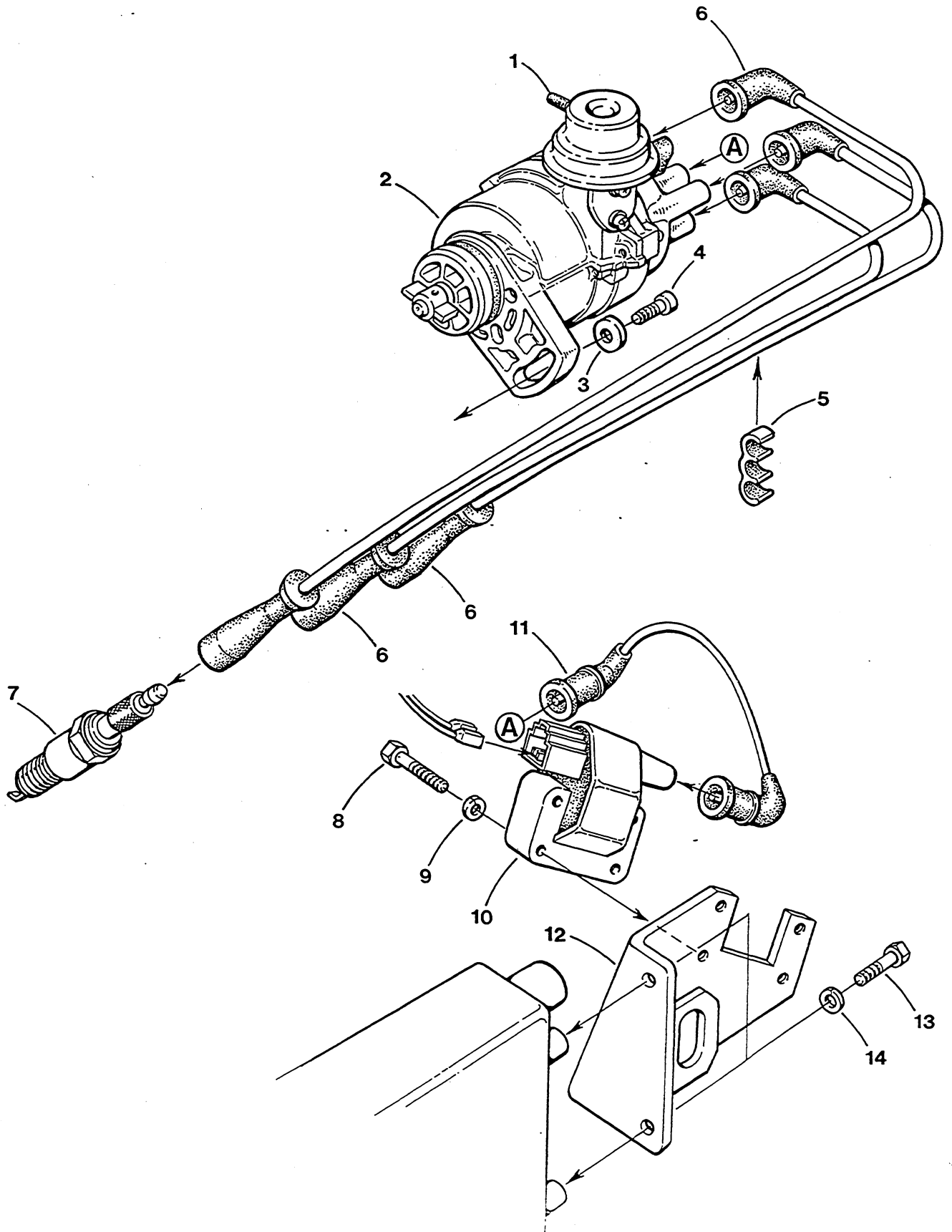

WESTERBEKE 4.5-7.2-9.6 BCGTC/E - DISTRIBUTOR - COIL - SPARKPLUGS

REF	PN	NAME	REMARKS	QUAN
1	033885	CAP	VINYL	1
2	042488	DISTRIBUTR	INCLUDING REF 1	1
3	033381	WASHER		1
4	041569	CAPSCREW	SECURITY PIN	1
5	042991	CLAMP	SPARKPLUG WIRES	1
6	043060	WIRE SET	SPARKPLUG AND COIL	1
7	043071	SPARKPLUG		3
8	038914	SCREW	M 5 X 25 DIN 84A PHILLIPS	4
9	031780	LOCKWASHER	M 5 DIN 127	4
10	042520	COIL	IGNITION	1
11		WIRE	COIL-SEE REF 6	1
12	042290	BRACKET	COIL AND LIFTING EYE	1
13	017012	CAPSCREW	M 6 X 16 DIN 933	2
14	031783	LOCKWASHER	M 6 DIN 127	2

WESTERBEKE 4.5-7.2-9.6 BCGTC/E - DISTRIBUTOR

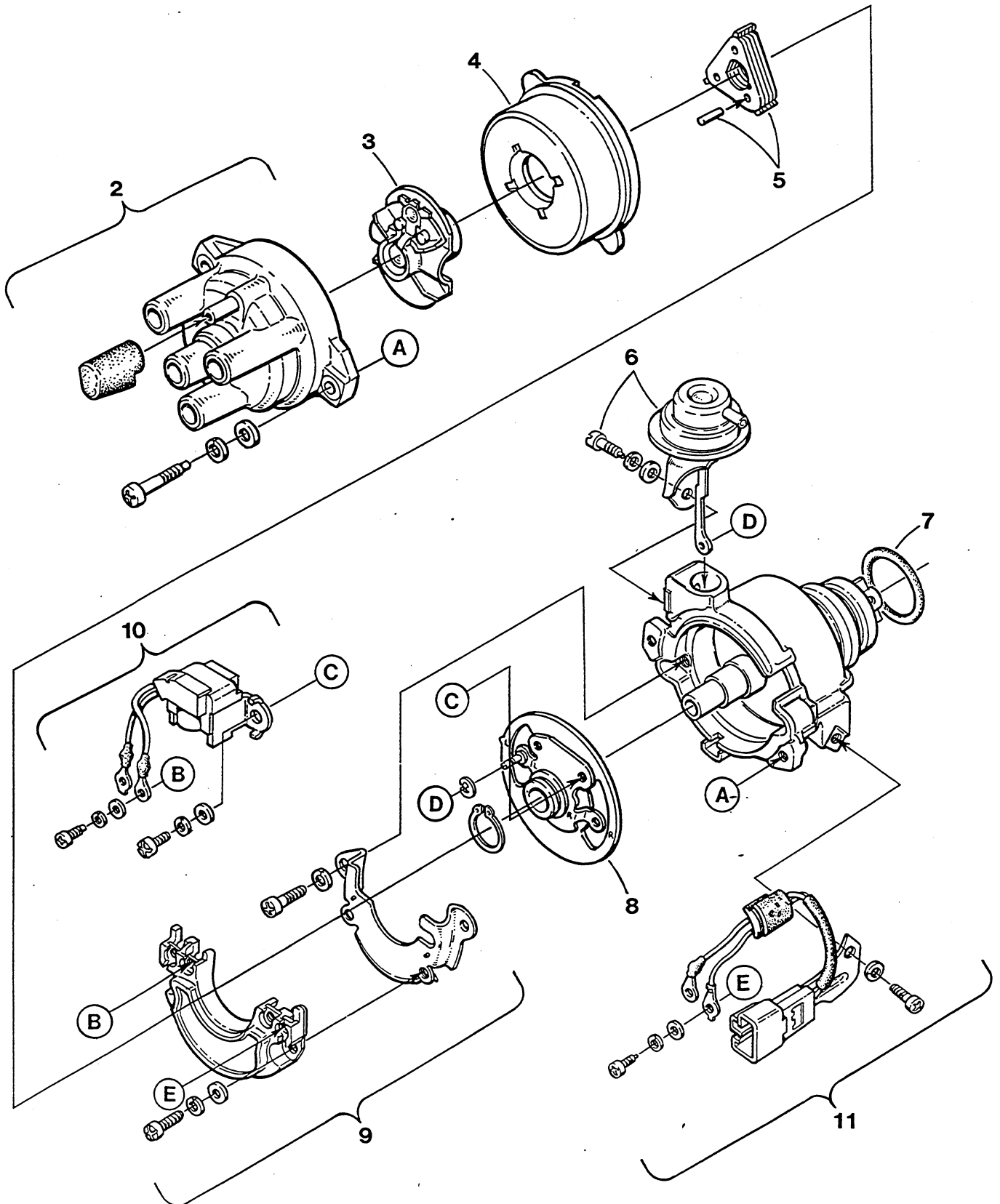

WESTERBEKE 4.5-7.2-9.6 BCGTC/E - DISTRIBUTOR

REF	PN	NAME	REMARKS	QUAN
1	042488	DISTRIBUTR	ASSEMBLY	1
2	043059	CAP	DISTRIBUTOR INCLUDING SCREWS	1
3	043050	ROTOR		1
4	043056	COVER	DISTRIBUTOR BREAKER	1
5	043055	ROTOR	DISTRIBUTOR IGNITER SIGNAL	1
6	043057	MODULE	DISTRIBUTOR VACUUM ADVANCE INCL SCREWS	1
7	043049	O-RING		1
8	043052	BREAKER	DISTRIBUTOR	1
9	043053	IGNITER	KIT INCLUDING SCREWS	1
10	043054	MODULE	DISTRIBUTOR PICKUP INCLUDING SCREWS	1
11	043058	CABLE	DISTRIBUTOR INCLUDING SCREWS	1
12	043051	SCREW SET	ALL SCREWS FOR REF 6 THRU 11	1

WESTERBEKE 4.5-7.2-9.6 BCGTC/E - INTAKE MANIFOLD

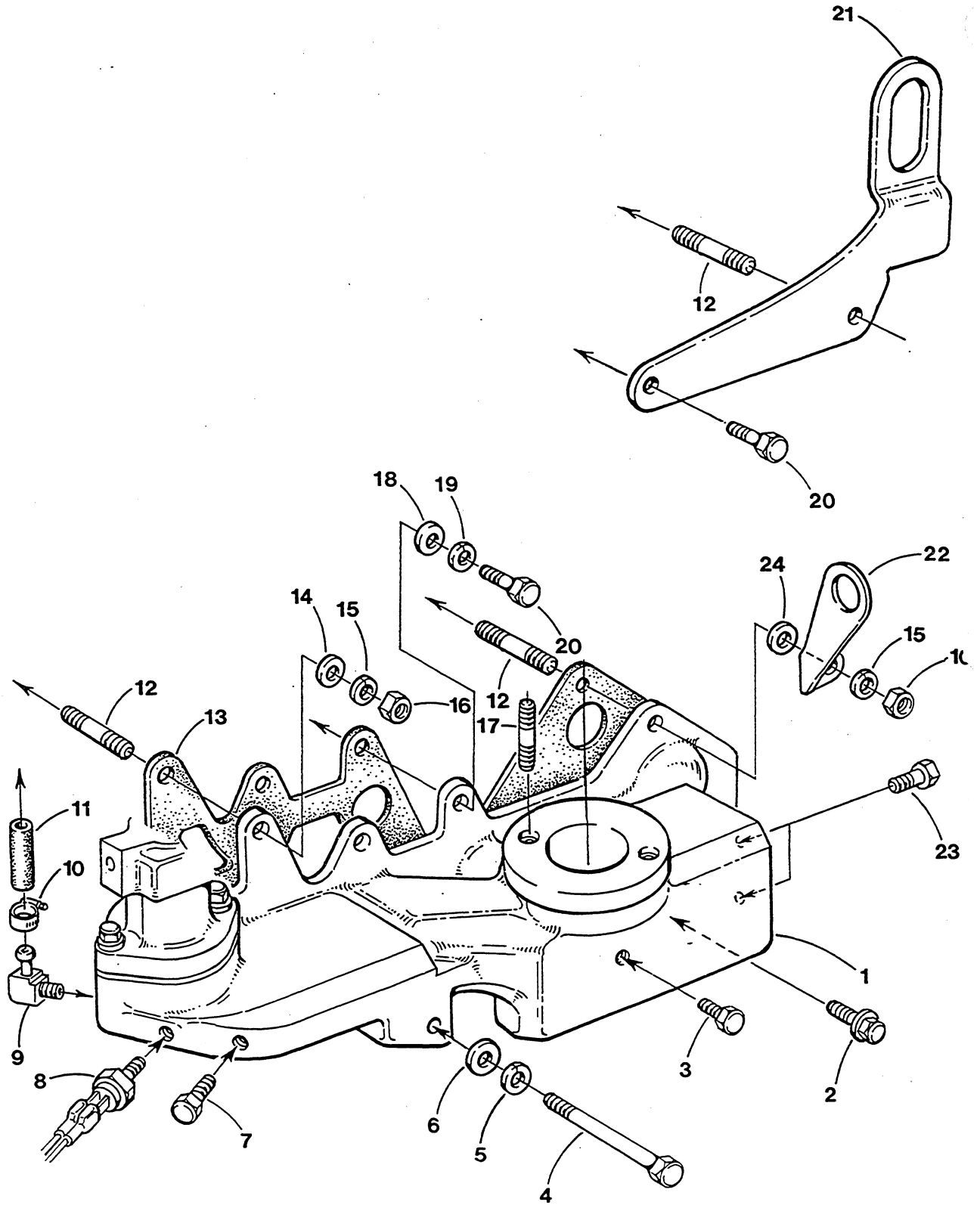

WESTERBEKE 4.5-7.2-9.6 BCGTC/E - INTAKE MANIFOLD

REF	PN	NAME	REMARKS	QUAN
1-1	043412	MANIFOLD	INTAKE BCGTC	1
1-2	042076	MANIFOLD	INTAKE BCGTE	1
2	033641	CAPSCREW	M 8 X 16 JIS-FLANGE	1
3-1	019369	PLUG	1/8 NPT HEX HEAD BRASS BCGTC	1
3-2	042616	ELBOW	1/8 NPT TO 1/4" HOSE BCGTE	1
4	024983	CAPSCREW	M 8 X 75 DIN 931	1
5	031786	LOCKWASHER	M 8 DIN 127	1
6	031787	WASHER	M 8 DIN 125	1
7-1	019369	PLUG	1/8 NPT HEX HEAD BRASS BCGTC	1
7-2	042749	SENSOR	WATER BCGTE	1
8	039550	SWITCH	WATER TEMPERATURE	1
9	042616	ELBOW	1/8 NPT TO 1/4" HOSE	1
10	040384	CLAMP	HOSE	1
11	036869	HOSE	3/16" ID - INCHES REQUIRED	2
12	015830	STUD	M 8 X 25 DIN 939	2
13	043287	GASKET	MANIFOLD TO HEAD	1
14	031787	WASHER	M 8 DIN 125	1
15	031786	LOCKWASHER	M 8 DIN 127	2
16	018242	NUT	M 8 DIN 934	2
17	042689	STUD	M 6 X 20 DIN 939	2
18	031787	WASHER	M 8 DIN 125	4
19	031786	LOCKWASHER	M 8 DIN 127	4
20-1	017196	CAPSCREW	M 8 X 20 DIN 933	3
20-2	013630	CAPSCREW	M 8 X 25 DIN 933	1
21	043216	EYE	LIFTING BCGTC	1
22	042986	EYE	LIFTING BCGTE	1
23	019369	PLUG	1/8 NPT HEX HEAD BRASS BCGTE	2
24	031787	WASHER	M 8 DIN 125 BCGTE	1

WESTERBEKE 4.5-7.2-9.6 BCGTC - AIR INTAKE AND CARBURETOR MOUNTING

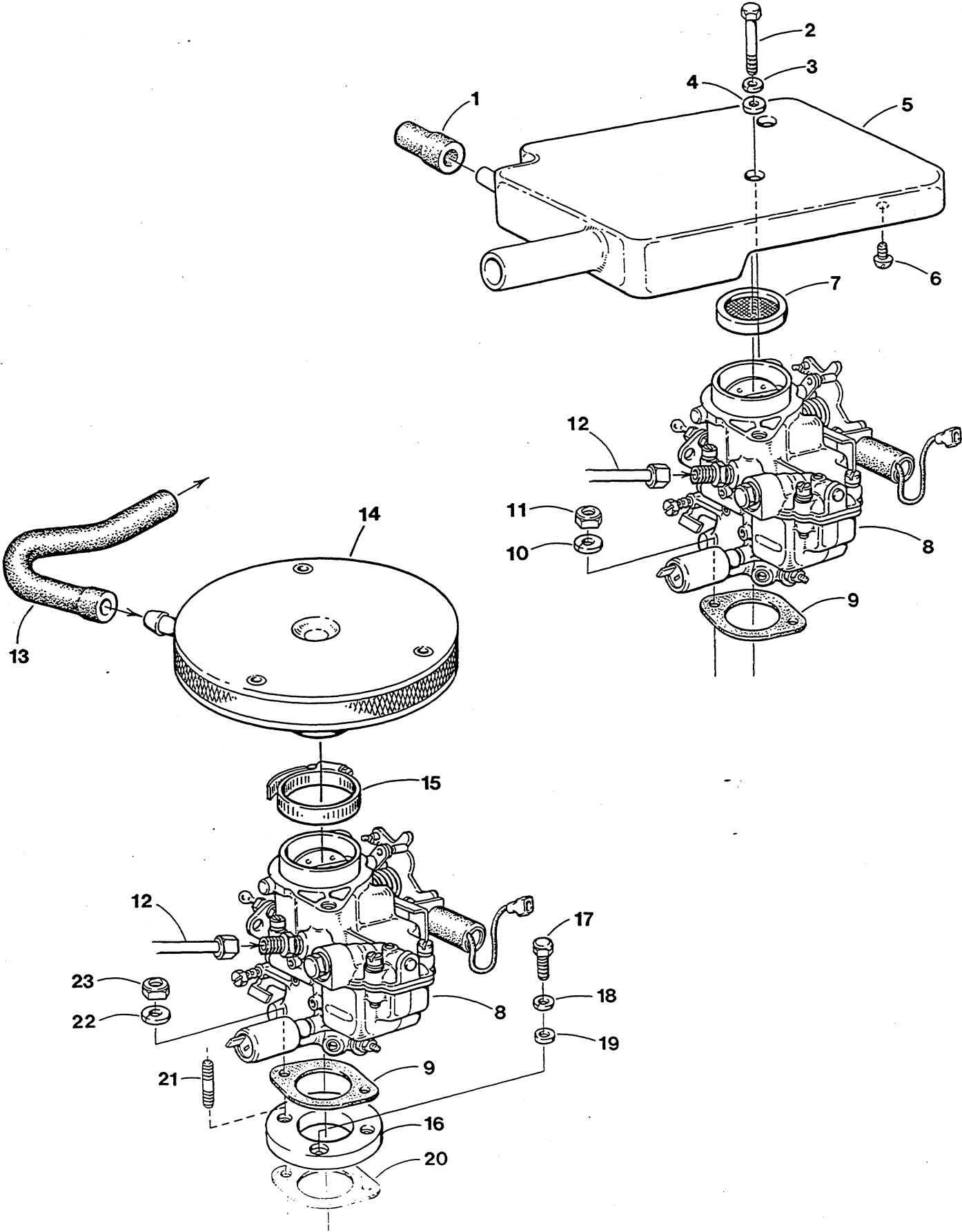

WESTERBEKE 4.5-7.2-9.6 BCGTC - AIR INTAKE AND CARBURETOR MOUNTING

REF	PN	NAME	REMARKS	QUAN
1	035894	HOSE	BREATHER - CUT TO FIT	1
2	034213	CAPSCREW	M 6 X 40 DIN 931	2
3	031783	LOCKWASHER	M 6 DIN 127	2
4	031784	WASHER	M 6 DIN 125	2
5	044356	SILENCER	AIR INTAKE INCLUDING REF 6 & 7	1
6	031889	SCREW	1/4 X 1/2 TAPPING	1
7	043438	ARRESTOR	FLAME	1
8	042776	CARBURETOR		1
9	035293	GASKET	CARBURETOR MOUNTING	1
10	031783	LOCKWASHER	M 6 DIN 127	2
11	015812	NUT	M 6 DIN 934	2
12	042825	LINE	GASDENSER TO CARBURETOR	1
13	035894	HOSE	BREATHER	1
14	035289	ARRESTOR	FLAME - USE REF 1 THRU 5	1
15	038193	CLAMP	HOSE 28	1
16	042726	ADAPTER	CARBURETOR TO MANIFOLD - TO AUG 98	1
17	017012	CAPSCREW	M 6 X 16 DIN 933	2
18	031783	LOCKWASHER	M 6 DIN 127	2
19	031784	WASHER	M 6 DIN 125	2
20	042311	GASKET	ADAPTER 42726 TO MANIFOLD	1
21-1	035337	STUD	1/4NC X 1-1/8 TO AUG 98	2
21-2	042689	STUD	M 6 X 20 DIN 939 FROM AUG 98	2
22-1	031752	LOCKWASHER	1/4 TO AUG 98	2
22-2	031783	LOCKWASHER	M 6 DIN 127 FROM AUG 98	2
23-1	031750	NUT	1/4NC HEX TO AUG 98	2
23-2	015812	NUT	M 6 DIN 934 FROM AUG 98	2

WESTERBEKE 4.5-7.2-9.6 BCGTC - CARBURETOR

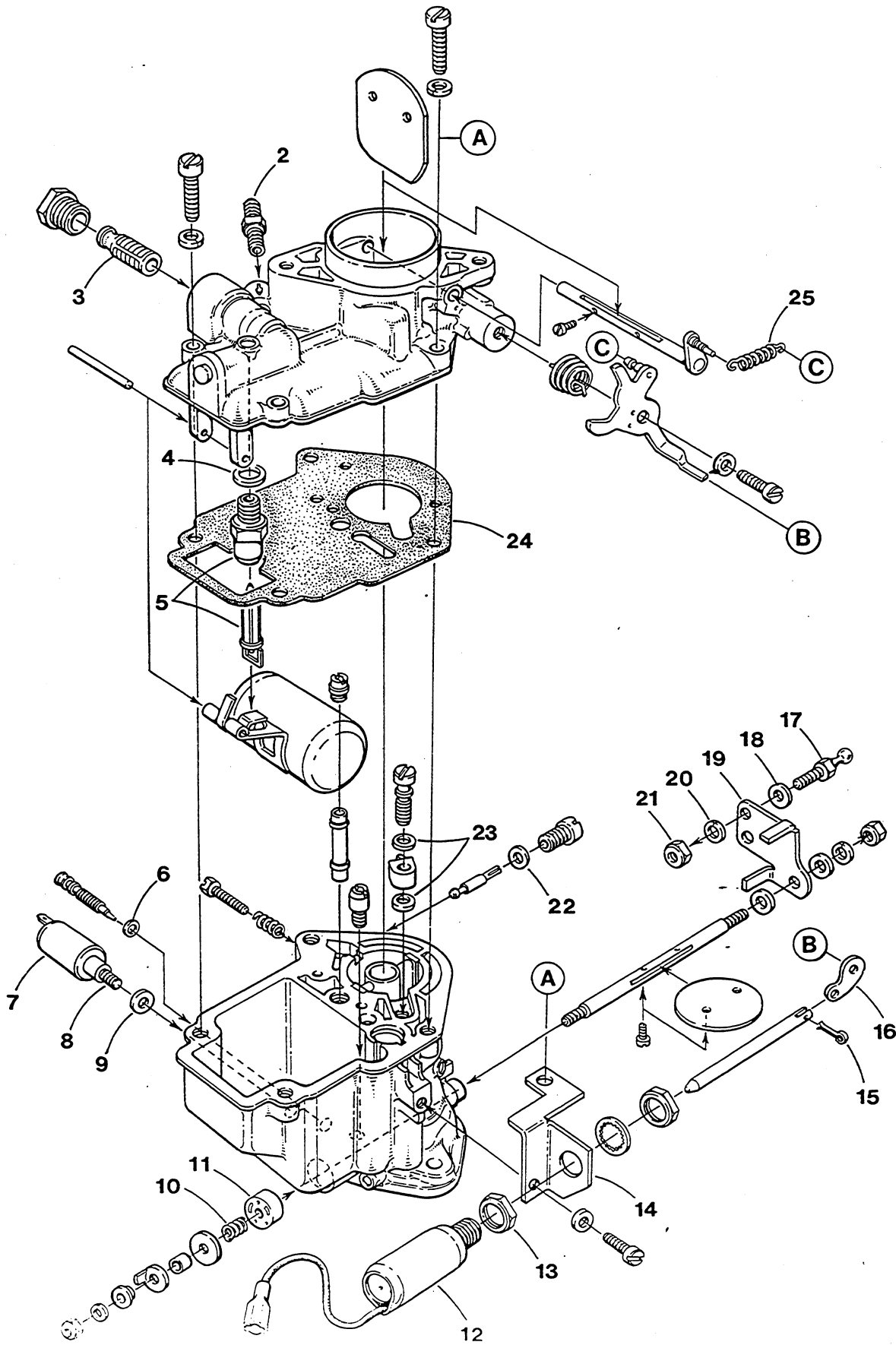

WESTERBEKE 4.5-7.2-9.6 BCGTC - CARBURETOR

REF	PN	NAME	REMARKS	QUAN
1	042776	CARBURETOR		1
2-1	013346	CONNECTOR	MALE 1/8 NPT TO 3/16 COMPRESSION	1
2-2	013344	NUT	3/16 COMPRESSION	1
2-3	013343	FERRULE	3/16 COMPRESSION	1
3	038090	FILTER	FUEL	1
4	036276	GASKET	NEEDLE VALVE	1
5	038097	VALVE	NEEDLE & SEAT	1
6	038092	GASKET	IDLE SCREW	1
7	043800	SOLENOID	INCLUDING JET	1
8	042732	JET	112	1
9	037846	WASHER		1
10	038094	SPRING	ROTARY VALVE	1
11	038096	VALVE	ROTARY	1
12	038038	SOLENOID	CHOKE 12 VDC	1
13	038042	NUT	15/32-32	1
14	037751	BRACKET	CHOKE SOLENOID	1
15	011796	PIN	COTTER 1/16 X 1/2 SS	1
16	037819	LINKAGE	SOLENOID	1
17	019364	BALLJOINT		1
18	031848	WASHER	10 FLAT SS	1
19	035291	LEVER	THROTTLE	1
20	031849	LOCKWASHER	10 SS	1
21	031847	NUT	10-32 HEX SS	1
22	038091	GASKET	IDLE JET	1
23	036275	GASKET	ACCELERATOR PUMP JET	2
24	038093	GASKET	COVER	1
25	038041	SPRING		1
26	038100	KIT	CARBURETOR REPAIR 3-5-6-10-11-22-23-24	1

WESTERBEKE 4.5-7.2 BCGTE - THROTTLE BODY - FUEL REGULATOR - INJECTOR

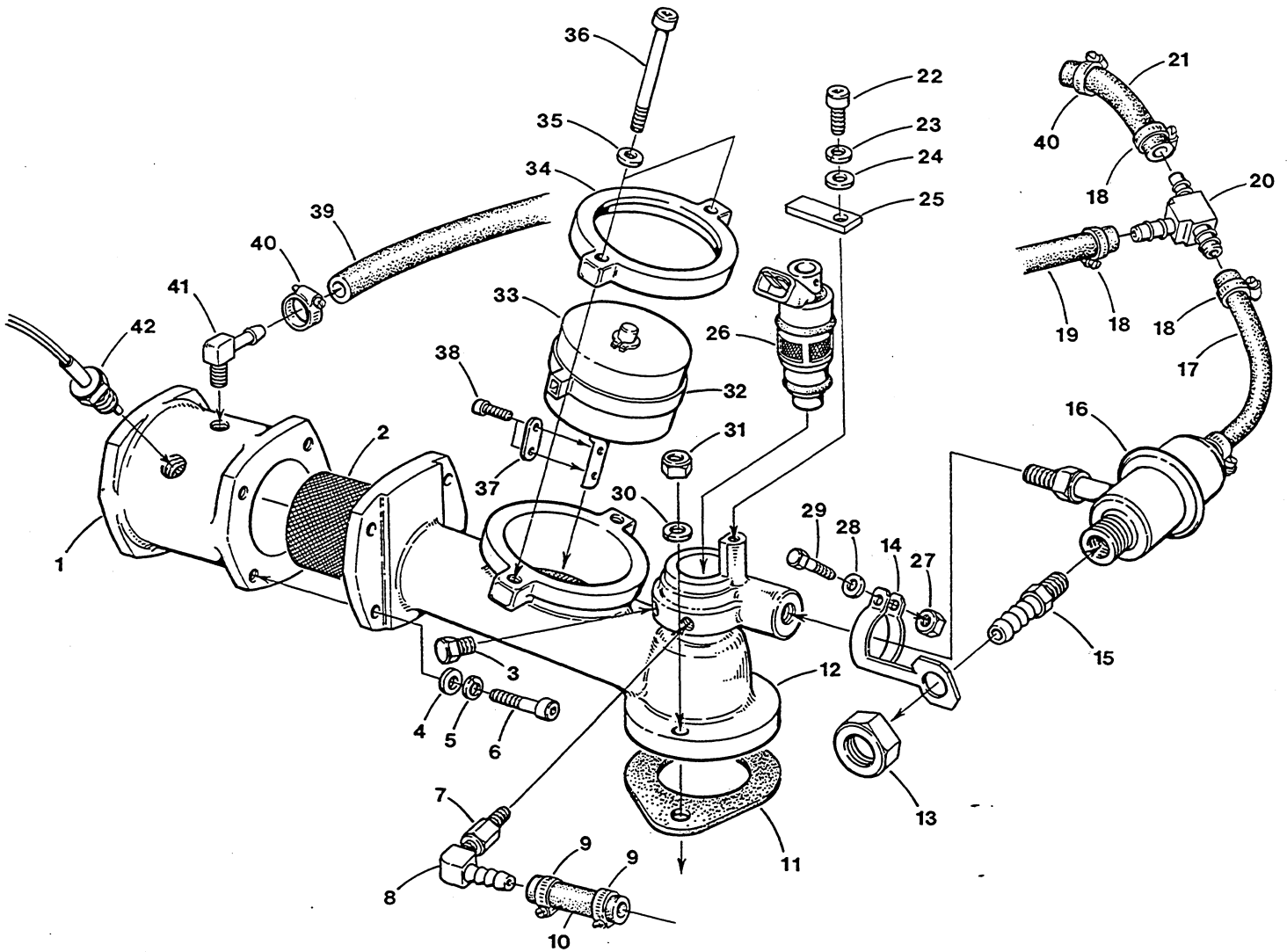

WESTERBEKE 4.5-7.2 BCGTE - THROTTLE BODY - FUEL REGULATOR - INJECTOR

REF	PN	NAME	REMARKS	QUAN
1	042445	HOUSING	FLAME ARRESTOR	1
2	042584	SCREEN	FLAME ARRESTOR	1
3	042738	VALVE	TEST	1
4	031781	WASHER	M 5 DIN 125	4
5	031780	LOCKWASHER	M 5 DIN 127	4
6	042632	CAPSCREW	M 5 X 20 DIN 912	4
7	013339	ADAPTER	1/8 NPT MALE-FEMALE	1
8	042671	ELBOW	1/8 NPT TO 5/16" HOSE	1
9	011341	CLAMP	HOSE 8	2
10	042680	HOSE	5/16" FUEL - INCHES REQUIRED	2
11	042311	GASKET	THROTTLE BODY TO MANIFOLD	1
12	042625	BODY	THROTTLE	1
13	031826	NUT	5/8NF JAM HEX	1
14	042629	CLAMP	FUEL REGULATOR	1
15	042668	ADAPTER	REGULATOR	1
16	042443	REGULATOR	FUEL PRESSURE	1
17	036869	HOSE	3/16" REGULATOR TO TEE - INCHES REQUIRED	9
18	040384	CLAMP	HOSE	5
19	036869	HOSE	3/16" TEE TO MANIFOLD - INCHES REQUIRED	6
20	042617	TEE		1
21	036869	HOSE	3/16" TEE TO MAP SENSOR - INCHES REQD	9
22	042632	CAPSCREW	M 5 X 20 DIN 912	1
23	031780	LOCKWASHER	M 5 DIN 127	1
24	031781	WASHER	M 5 DIN 125	1
25	042309	TAB	INJECTOR RETAINING	1
26	042221	INJECTOR	FUEL	1
27	018241	NUT	M 5 DIN 934	1
28	031780	LOCKWASHER	M 5 DIN 127	1
29	018248	CAPSCREW	M 5 X 25 DIN 933	1
30	031783	LOCKWASHER	M 6 DIN 127	2
31	015812	NUT	M 6 DIN 934	2
32	050208	TIEWRAP		1
33	042135	ACTUATOR	ROTARY	1
34	042773	BRACKET	ACTUATOR HOLD DOWN	1
35	031780	LOCKWASHER	M 5 DIN 127	2
36	031919	CAPSCREW	M 5 X 35 DIN 912	2
37	042308	PLATE	THROTTLE	1
38	042692	CAPSCREW	M 2 X 6 DIN 912	2
39	035435	HOSE	5/16" - INCHES REQUIRED	8
40	024906	CLAMP	HOSE 4	3
41	024907	ELBOW		1
42	042748	SENSOR	AIR	1

WESTERBEKE 4.5-7.2 BCGTE - FUEL FILTER AND ELECTRONIC PUMP

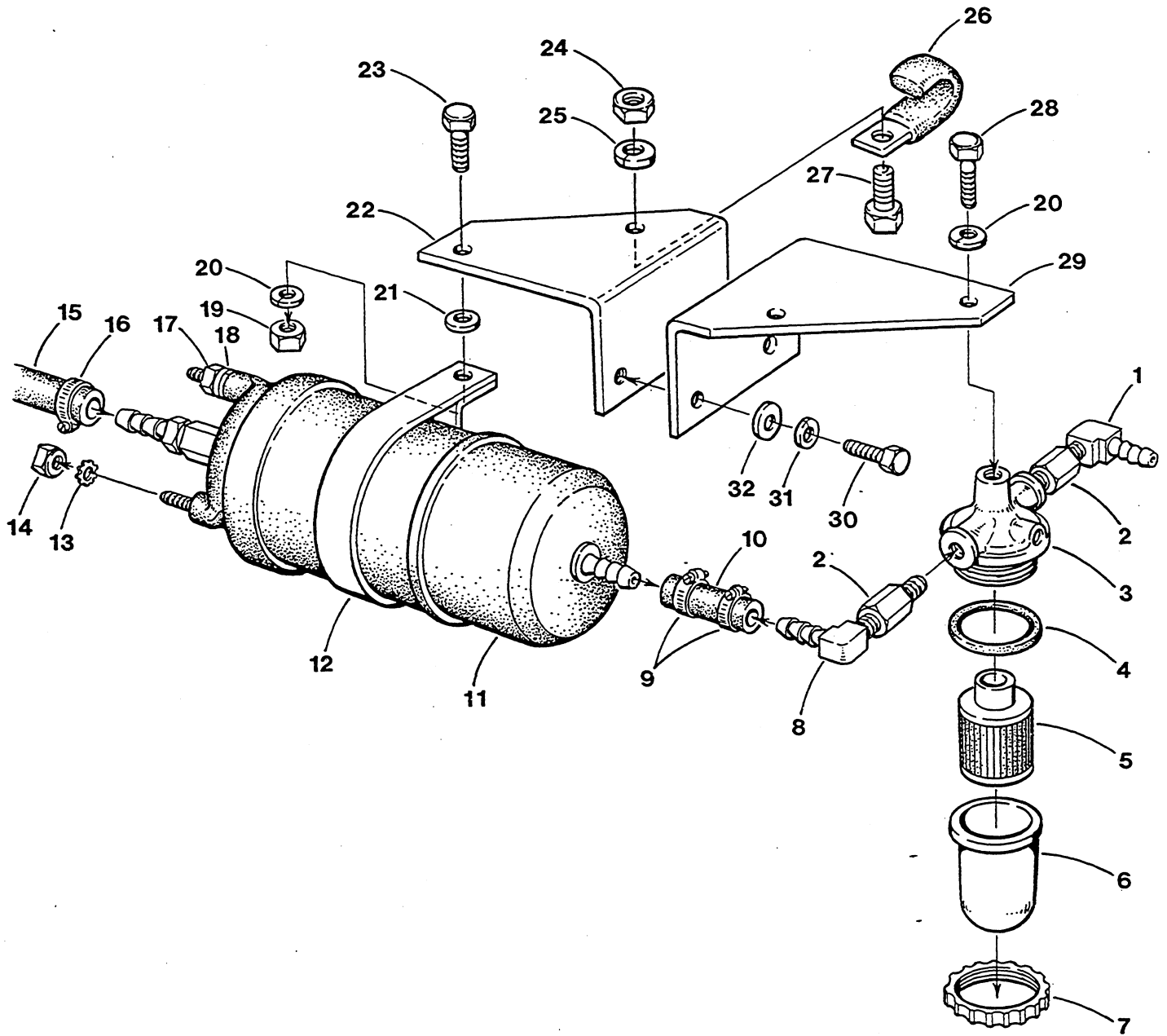

WESTERBEKE 4.5-7.2 BCGTE - FUEL FILTER AND ELECTRONIC PUMP

REF	PN	NAME	REMARKS	QUAN
1	042794	ELBOW	MALE 1/4 NPT TO 1/2" HOSE	1
2	042669	ADAPTER	1/8 BSPT TO 1/4 NPT	2
3	042817	FILTER	FUEL INCLUDING REF 3 THRU 7	1
4	040879	O-RING		1
5	040838	ELEMENT	FUEL FILTER	1
6	040878	CUP	FUEL FILTER	1
7	042410	NUT	FUEL FILTER	1
8	042926	ELBOW	MALE 1/4 NPT TO 1/2" HOSE	1
9	024906	CLAMP	HOSE 4	2
10	042727	HOSE	1/2" FUEL - INCHES REQUIRED	2
11	042190	PUMP	ELECTRONIC FUEL	1
12	039949	CLAMP		1
13	031914	LOCKWASHER	M 5 DIN 6797A	1
14	038348	NUT	M 5 BRASS	1
15	042680	HOSE	5/16" FUEL - INCHES REQUIRED	2
16	011341	CLAMP	HOSE 8	2
17	031929	NUT	M 4 DIN 934	1
18	031917	LOCKWASHER	M 4 DIN 6797A	1
19	024950	NUT	M10 X 1.25 DIN 934	1
20	019262	LOCKWASHER	M10 DIN 127	2
21	031789	WASHER	M10 DIN 125	1
22	042681	BRACKET	FUEL PUMP	1
23	024952	CAPSCREW	M10 X 1.25 X 25 DIN 961	1
24	015812	NUT	M 6 DIN 934	1
25	031783	LOCKWASHER	M 6 DIN 127	1
26	038074	CLAMP	CABLE	1
27	017012	CAPSCREW	M 6 X 16 DIN 933	1
28	024951	CAPSCREW	M10 X 1.25 X 20 DIN 961	1
29	042682	BRACKET	FUEL FILTER	1
30	013629	CAPSCREW	M10 X 25 DIN 933	1
31	019262	LOCKWASHER	M10 DIN 127	1
32	031789	WASHER	M10 DIN 125	1

WESTERBEKE 4.5-7.2-9.6 BCGTC/E - BACK END - GENERATOR - REAR MOUNTS

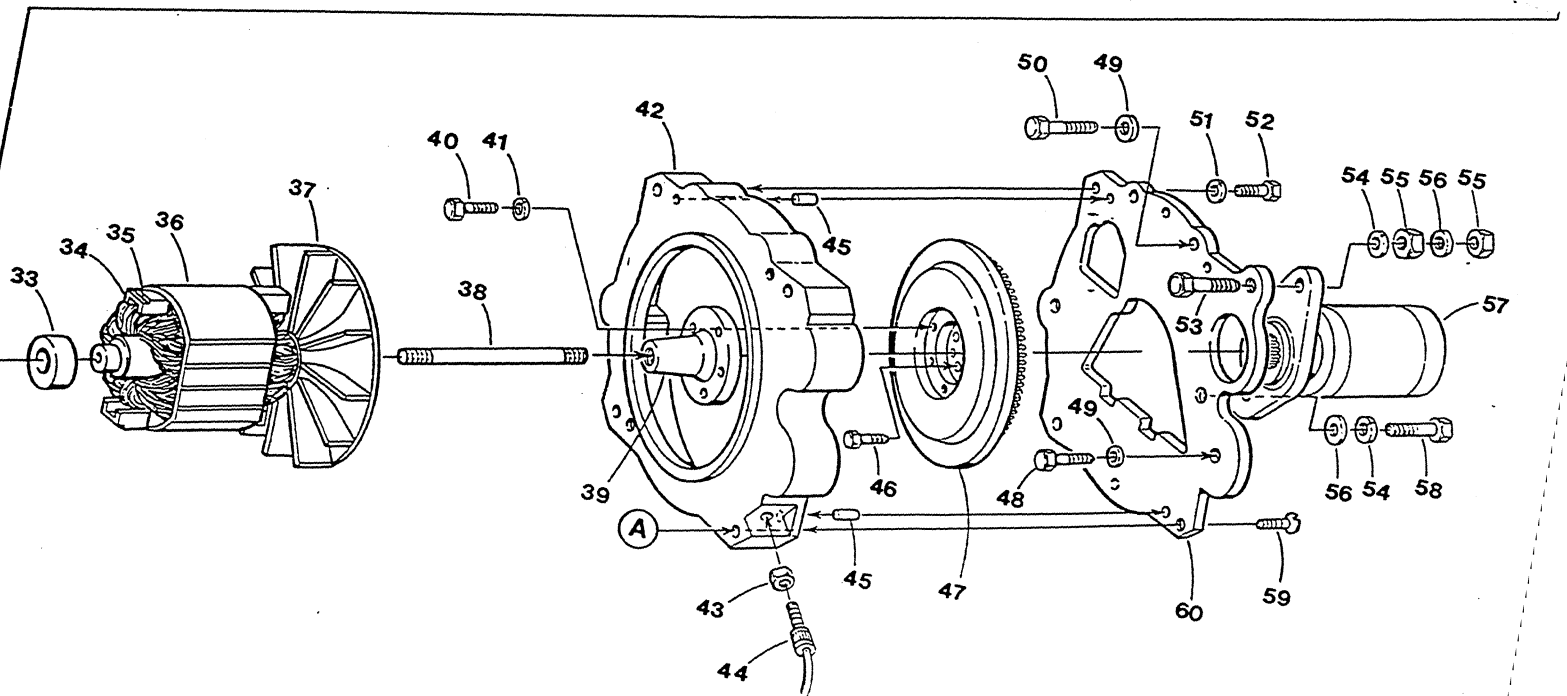
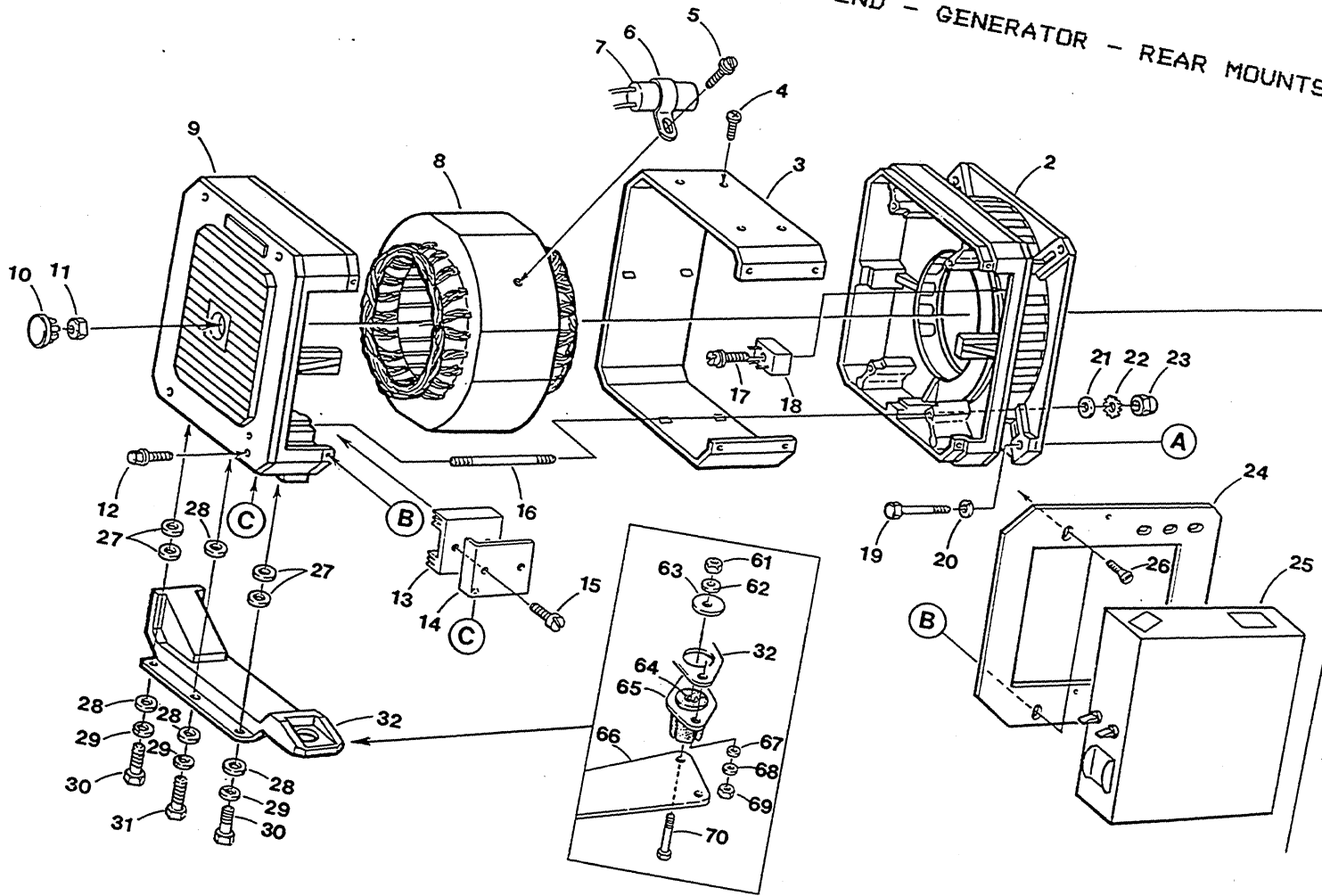

WESTERBEKE 4.5-7.2-9.6 BCGTC/E - BACK END - GENERATOR - REAR MOUNTS

REF	PN	NAME	REMARKS	QUAN
1-1	043483	GENERATOR	4.5KW	1
1-2	043498	GENERATOR	7.2KW	1
1-3	043497	GENERATOR	9.6KW	1
2-1	044948	HOUSING	FRONT 4.5KW	1
2-2	044947	HOUSING	FRONT 7.2-9.6KW	1
3-1	043524	COVER	STATOR 4.5KW	1
3-2	044957	COVER	STATOR 7.2KW	1
3-3	044958	COVER	STATOR 9.6KW	1
4	044939	SCREW	6 X 3/8 TAPPING SS	AR
5	031918	SCREW	M 5 X 10 DIN 84A	1
6-1	035979	CLAMP	CAPACITOR 4.5KW	1
6-2	044959	CLAMP	CAPACITOR 7.2-9.6KW	1
7-1	035985	CAPACITOR	4.5KW 25MFD	1
7-2	035978	CAPACITOR	7.2KW 31.5MFD	1
7-3	041199	CAPACITOR	9.6KW 35MFD	1
8-1	044949	STATOR	4.5KW	1
8-2	044950	STATOR	7.2KW	1
8-3	044951	STATOR	9.6KW	1
9-1	044940	HOUSING	REAR 4.5KW	1
9-2	044941	HOUSING	REAR 7.2-9.6KW	1
10	042806	PLUG	NYLON	1
11	043623	NUT	5/16NF LOCKING	1
12	031918	SCREW	M 5 X 10 DIN 84A	3
13-1	043096	CHARGER	BATTERY	1
13-2	038469	CHARGER	BATTERY-UNITS WITH "L" AT END OF SERIAL#	1
14	044960	BRACKET	CHARGER MOUNT	1
15	031918	SCREW	M 5 X 10 DIN 84A	2
16-1	044954	STUD	HOUSING 4.5KW	4
16-2	044952	STUD	HOUSING 7.2KW	4
16-3	044953	STUD	HOUSING 9.6KW	4
17	031931	SCREW	M 5 X 16 DIN 84A	1
18	043649	RECTIFIER	BRIDGE	1
19	013630	CAPSCREW	M 8 X 25 DIN 933	4
20	031786	LOCKWASHER	M 8 DIN 127	4
21	031784	WASHER	M 6 DIN 125	4
22	031783	LOCKWASHER	M 6 DIN 127	4
23	044943	NUT	M 6 DIN 1587	4
24	042874	BRACKET	PANEL MOUNT	1
25		PANEL	REFER TO PANEL PAGES	1
26	042816	SCREW	8-32 X 1/2 SS FLAT HEAD	4
27	033381	WASHER	SPACER	4
28	031759	WASHER	5/16 FLAT	4
29	031758	LOCKWASHER	5/16	3
30	031555	CAPSCREW	5/16NC X 1	2
31	031553	CAPSCREW	5/16NC X 3/4	1
32-1	042374	MOUNT	REAR 4.5KW	1
32-2	042375	MOUNT	REAR 7.2KW	1
32-3	042251	MOUNT	REAR 9.6KW	1
33	014277	BEARING	BALL	1

WESTERBEKE 4.5-7.2-9.6 BCGTC/E - BACK END - GENERATOR - REAR MOUNTS

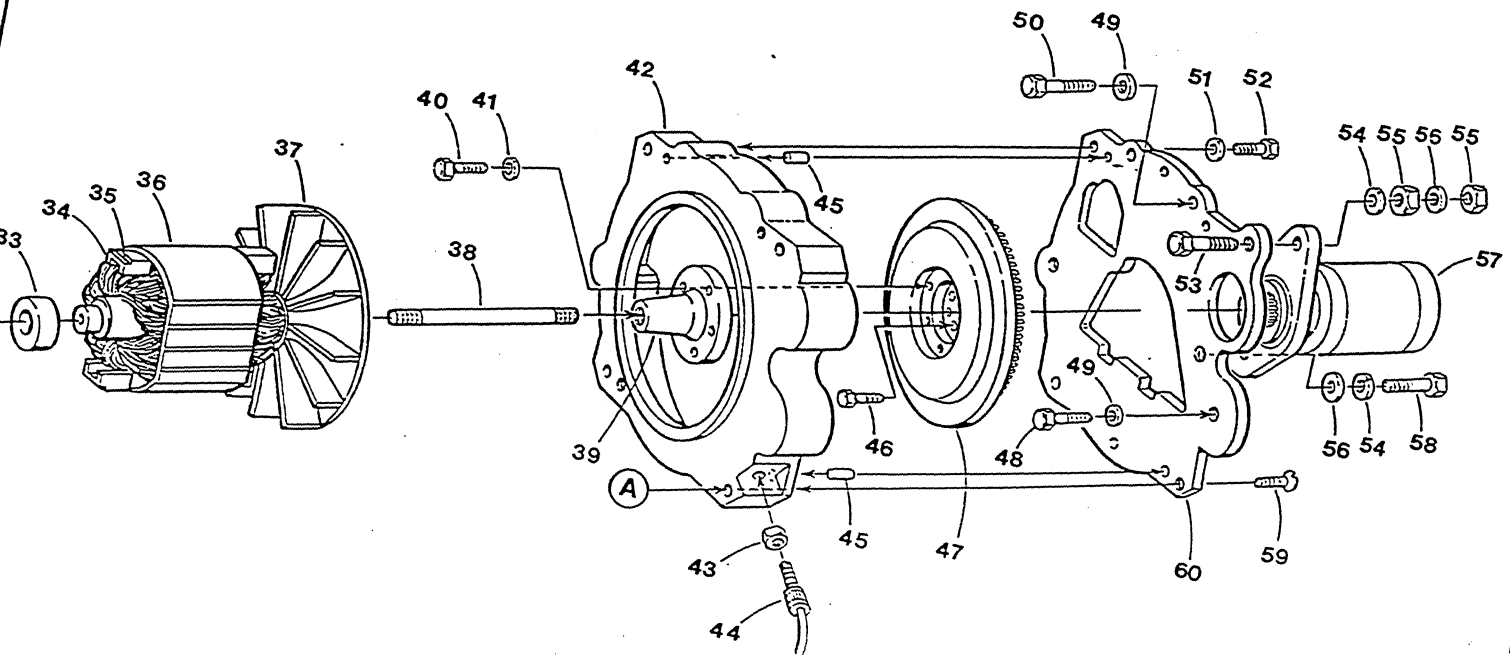
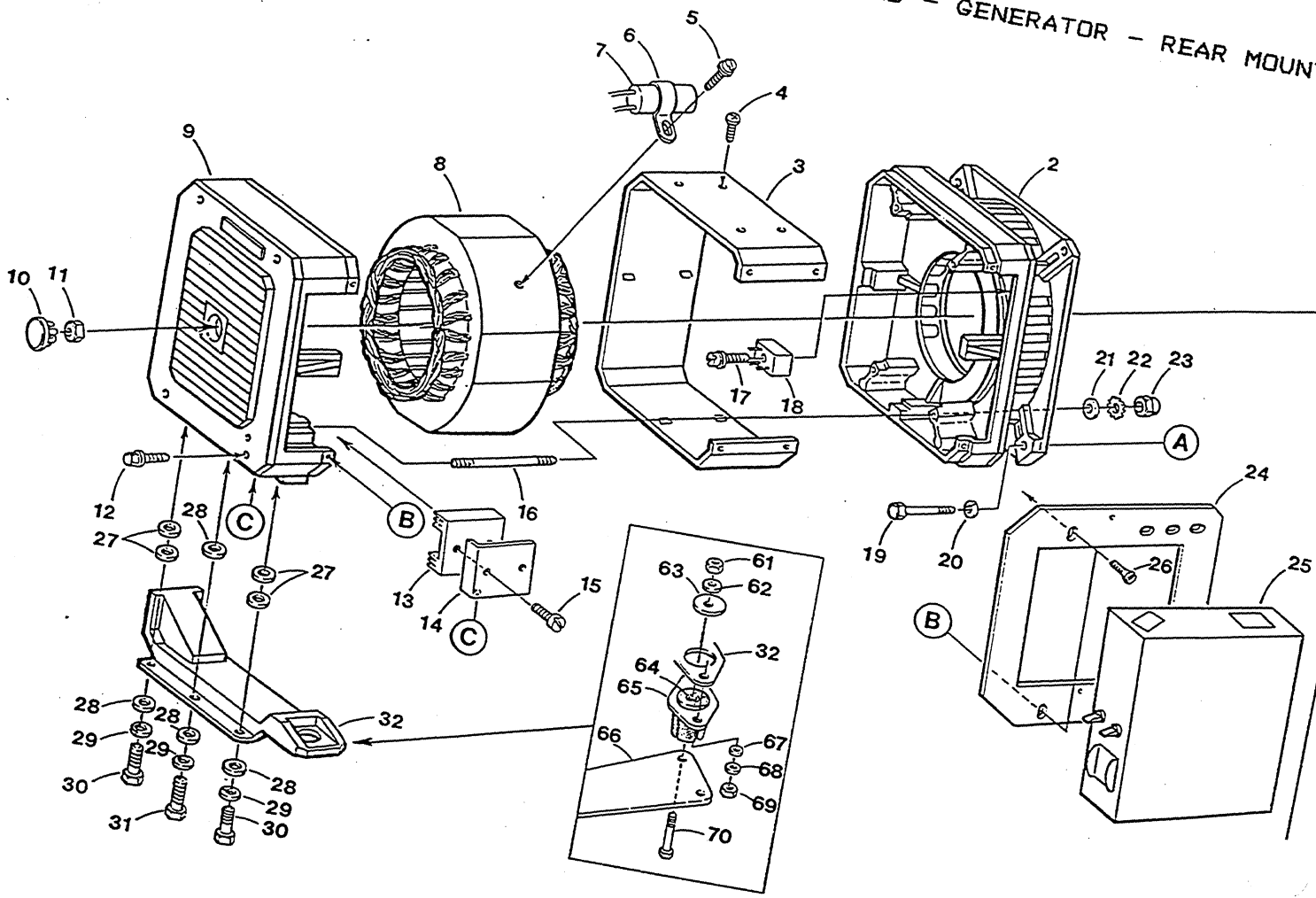

WESTERBEKE 4.5-7.2-9.6 BCGTC/E - BACK END - GENERATOR - REAR MOUNTS

REF	PN	NAME	REMARKS	QUAN
17-1	041472	FLYWHEEL	INCLUDING RING GEAR	1
34	044942	DIODE		2
35	044956	VARISTOR		2
36-1	044944	ARMATURE	4.5KW	1
36-2	044945	ARMATURE	7.2KW	1
36-3	044946	ARMATURE	9.6KW	1
37	044955	FAN		1
38-1	042596	STUD	ROTOR-THRU 4.5KW	1
38-2	042918	STUD	ROTOR-THRU 7.2KW	1
38-3	042736	STUD	ROTOR-THRU 9.6KW	1
39	040088	SHAFT		1
40	013629	CAPSCREW	M10 X 25 DIN 933	6
41	019262	LOCKWASHER	M10 DIN 127	6
42-1	043084	HOUSING	FLYWHEEL BCGTC	1
42-2	041460	HOUSING	FLYWHEEL BCGTE	1
43		NUT		1
44	039172	SENSOR	MAGNETIC SPEED BCGTE	1
45	013919	DOWEL		2
46	042964	BOLT	FLYWHEEL	5
47-2	032996	GEAR	RING	1
48	031228	CAPSCREW	M10 X 1.25 X 30 DIN 961	2
49	019262	LOCKWASHER	M10 DIN 127	4
50	024951	CAPSCREW	M10 X 1.25 X 20 DIN 961	2
51	031786	LOCKWASHER	M 8 DIN 127	3
52	013630	CAPSCREW	M 8 X 25 DIN 933	3
53	034470	CAPSCREW	M10 X 45 DIN 931	1
54	019262	LOCKWASHER	M10 DIN 127	2
55	031803	NUT	M10 DIN 936	2
56	031789	WASHER	M10 DIN 125	2
57	034552	MOTOR	STARTER	1
58	034589	CAPSCREW	M10 X 30 DIN 933	1
59	042598	SCREW	M 8 X 20 DIN 9771 FLAT HEAD SOCKET	1
60	041574	PLATE	BACK	1
61	043139	NUT	M10 DIN 934 304SS	2
62	043138	LOCKWASHER	M10 DIN 127B 304SS	2
63	042303	WASHER	ISOLATOR REBOUND	2
64-1	042302	SPACER	RIGHT 1.66"LG	1
64-2	042821	SPACER	LEFT 1.79"LG	1
65	042810	ISOLATOR		2
66	042294	PLATE	REAR MOUNT	1
67	031784	WASHER	M 6 DIN 125	4
68	031783	LOCKWASHER	M 6 DIN 127	4
69	017012	CAPSCREW	M 6 X 16 DIN 933	4
70	043116	CAPSCREW	M10 X 70 DIN 7991 304SS	2

WESTERBEKE 4.5-7.2-9.6 BCGTC - GENERATOR CONTROL PANEL

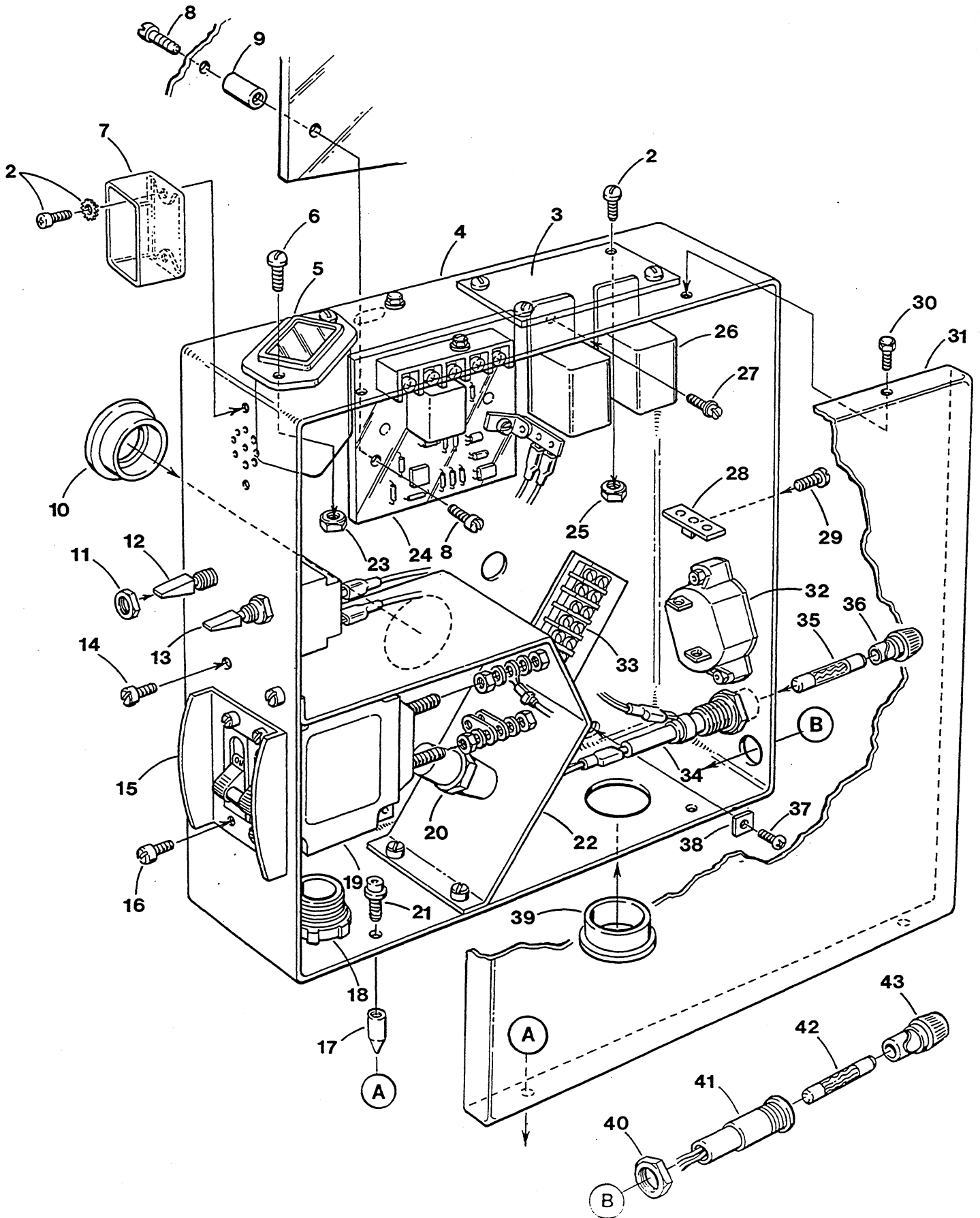

WESTERBEKE 4.5-7.2-9.6 BCGTC - GENERATOR CONTROL PANEL

REF	PN	NAME	REMARKS	QUAN
1-1	042735	PANEL	CONTROL INCL HARNESS EXCL AC BREAKER	1
1-2	042870	HARNESS		1
1-3	043897	PANEL	CONTROL-SRC INCL HARNESS EXCL AC BREAKER	1
1-4	043937	HARNESS	WITH REMOTE CONNECTOR	1
1-5	043818	CONNECTOR	WITH JUMPER WHEN REMOTE PANEL NOT INSTLD	1
2	031940	SCREW	6-32 X 3/8 W/LOCKWASHER	6
3	042781	PLATE	COVER	1
4	043415	BOX	PANEL	1
5	042388	HOURLMETER		1
6	031853	SCREW	6-32 X 3/8 SS BH	2
7	042253	DUCT	AIR IN	1
8	031852	SCREW	6-32 X 1/4 SS BH	4
9	041180	STANDOFF		2
10	023937	BUSHING		1
11	038042	NUT	SWITCH	2
12	042521	SWITCH	TOGGLE START-STOP	1
13	033632	SWITCH	TOGGLE ON	1
14	031940	SCREW	6-32 X 3/8 W/LOCKWASHER	4
15	039082	GUARD	AC BREAKER	1
16	031852	SCREW	6-32 X 1/4 SS BH	4
17	030775	GUIDE		2
18	042909	CONNECTOR	BOX 1"	1
19-1	043293	BREAKER	AC 20AMP 4.5KW 60HZ 3.75KW 50HZ	1
19-2	043294	BREAKER	AC 30AMP 7.2KW 60HZ 6.0KW 50HZ	1
19-3	043295	BREAKER	AC 40AMP 9.6KW 60HZ	1
19-4	043285	BREAKER	AC 35AMP 8.0KW 50HZ	1
20-1	043086	TERMINAL		1
20-2	043093	STUD	1/4NC X 1	1
20-3	031501	CAPSCREW	1/4NC X 1/2	1
20-4	031750	NUT	1/4NC HEX	1
20-5	031752	LOCKWASHER	1/4	2
20-6	031753	WASHER	1/4 FLAT	2
21	031940	SCREW	6-32 X 3/8 W/LOCKWASHER	2
22	042377	DIVIDER	BOX	1
23	050234	NUT	6-32 KEPS	2
24-1	043240	SHUTDOWN	OVERSPEED	1
24-2	042884	SHUTDOWN	OVERSPEED TO JAN 98	1
25	031837	NUT	6-32 HEX SS	4

WESTERBEKE 4.5-7.2-9.6 BCGTC - GENERATOR CONTROL PANEL

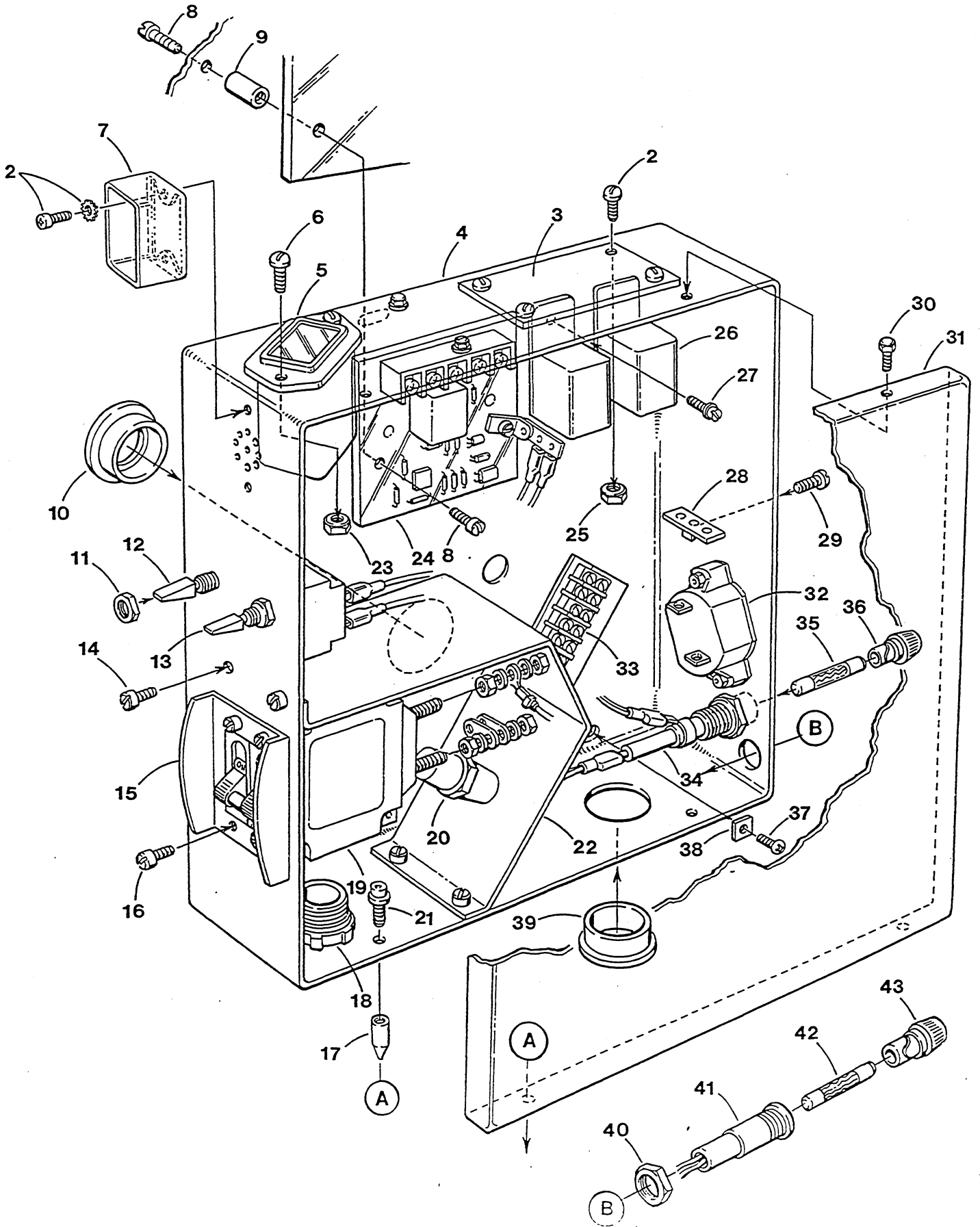

WESTERBEKE 4.5-7.2-9.6 BCGTC GENERATOR CONTROL PANEL

REF	PN	NAME	REMARKS	QUAN
26	041150	RELAY	12VDC 30AMP	2
27-1	043250	SCREW	6-32 X 3/16 SS	2
27-2	031838	WASHER	6 FLAT SS	2
28-1	042851	TERMINAL	DIODE ASSEMBLY TO JAN 98	2
28-2	043247	TERMINAL	DIODE ASSEMBLY-CHOKE TO JAN 98	1
29	031940	SCREW	6-32 X 3/8 W/LOCKWASHER TO JAN 98	2
30	043410	THUMBSCREW	6-32 X 3/8 SS	2
31	043411	COVER	PANEL BOX	1
32-1	043422	BREAKER	CIRCUIT 25 AMP	1
32-2	031865	SCREW	8-32 X 3/8 SS BH	2
32-3	031843	WASHER	8 FLAT SS	2
33-1	042496	BLOCK	TERMINAL 6 POSITION	1
33-2	042498	MARKER	TERMINAL BLOCK	1
33-3	042497	JUMPER		1
33-4	013855	PLATE	SCREW	1
33-5	031854	SCREW	6-32 X 1/2 SS BH	4
34	033767	HOLDER	FUSE INCLUDING CAP	1
35	033769	FUSE	8 AMP	1
36		CAP	FUSE HOLDER SEE REF 34	1
37	031937	SCREW	8-32 X 3/8 W/LOCKWASHER	3
38	042628	WASHER	PANEL MOUNTING	3
39	042933	BOOT		1
40		NUT	FUSE HOLDER	1
41	043828	HOLDER	FUSE	1
42	043634	FUSE	30 AMP	1
43	043829	CARRIER	FUSE	1

WESTERBEKE 4.5-7.2-9.6 BCGTC - ELECTRICAL SYSTEM

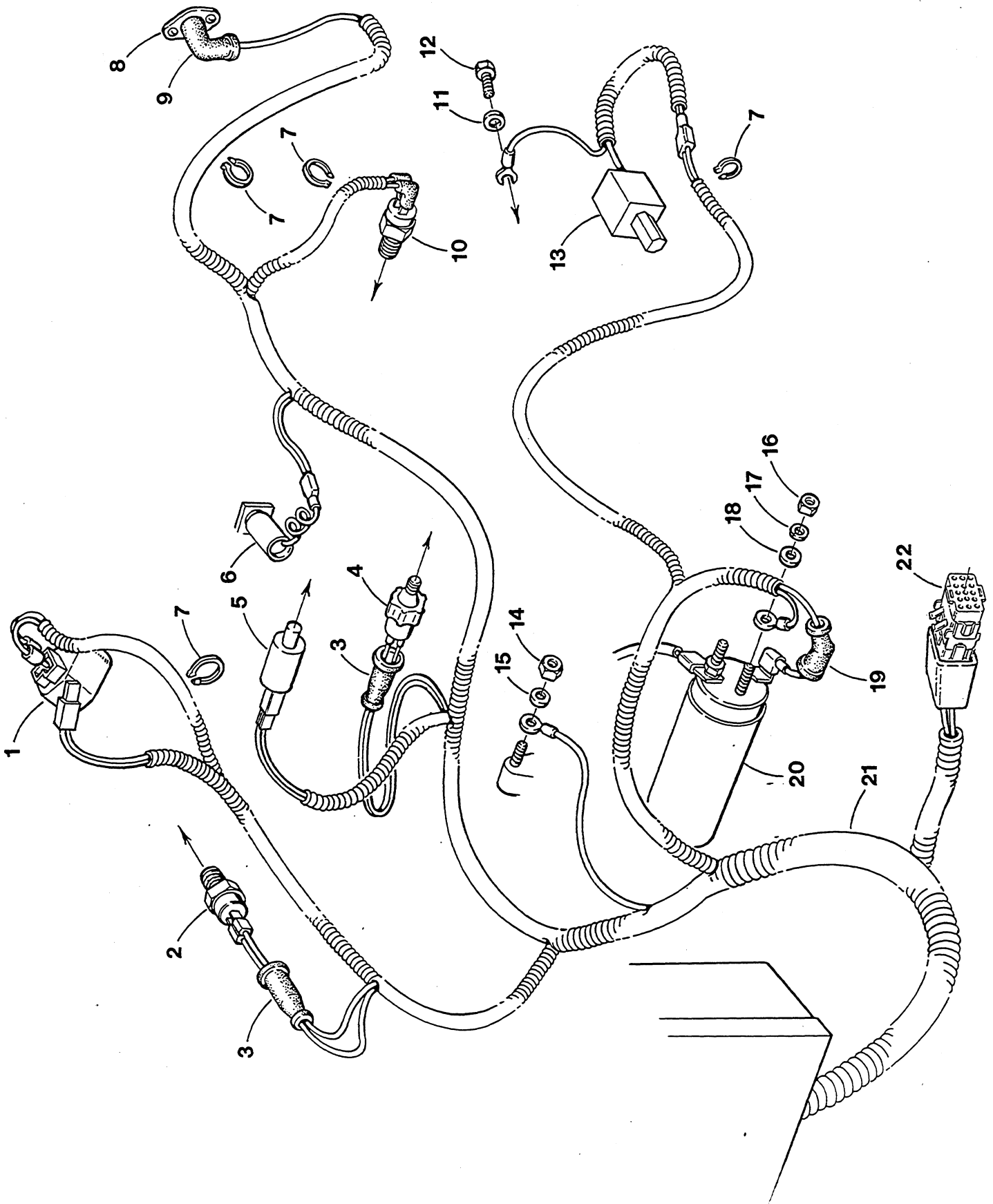

WESTERBEKE 4.5-7.2-9.6 BCGTC - ELECTRICAL SYSTEM

REF	PN	NAME	REMARKS	QUAN
1	042520	COIL	IGNITION	1
2	039550	SWITCH	WATER TEMPERATURE	1
3	035755	BOOT		2
4	037323	SWITCH	OIL PRESSURE	1
5	043800	SOLENOID	CARBURETOR INCLUDING JET	1
6	038038	SOLENOID	CHOKE 12 VDC	1
7	023809	TIEWRAP		AR
8	032923	SWITCH	EXHAUST TEMPERATURE	1
9	035754	BOOT		1
10	043242	SWITCH	OIL TEMPERATURE	1
11	031783	LOCKWASHER	M 6 DIN 127	1
12	017012	CAPSCREW	M 6 X 16 DIN 933	1
13	043124	PUMP	FUEL LIFT 12VDC	1
14	031803	NUT	M10 DIN 936	2
15-1	031789	WASHER	M10 DIN 125	2
15-2	019262	LOCKWASHER	M10 DIN 127	1
16	018242	NUT	M 8 DIN 934	1
17	031786	LOCKWASHER	M 8 DIN 127	1
18	031787	WASHER	M 8 DIN 125	1
19	034472	BOOT		1
20	036218	SOLENOID	STARTER	1
21-1	042870	HARNESS	GENSET	1
21-2	043937	HARNESS	GENSET WITH REMOTE PANEL CONNECTOR	1
22	043818	CONNECTOR	WITH JUMPER WHEN REMOTE PANEL NOT USED	1

WESTERBEKE 4.5-7.2 BCGTE - GENERATOR CONTROL PANEL

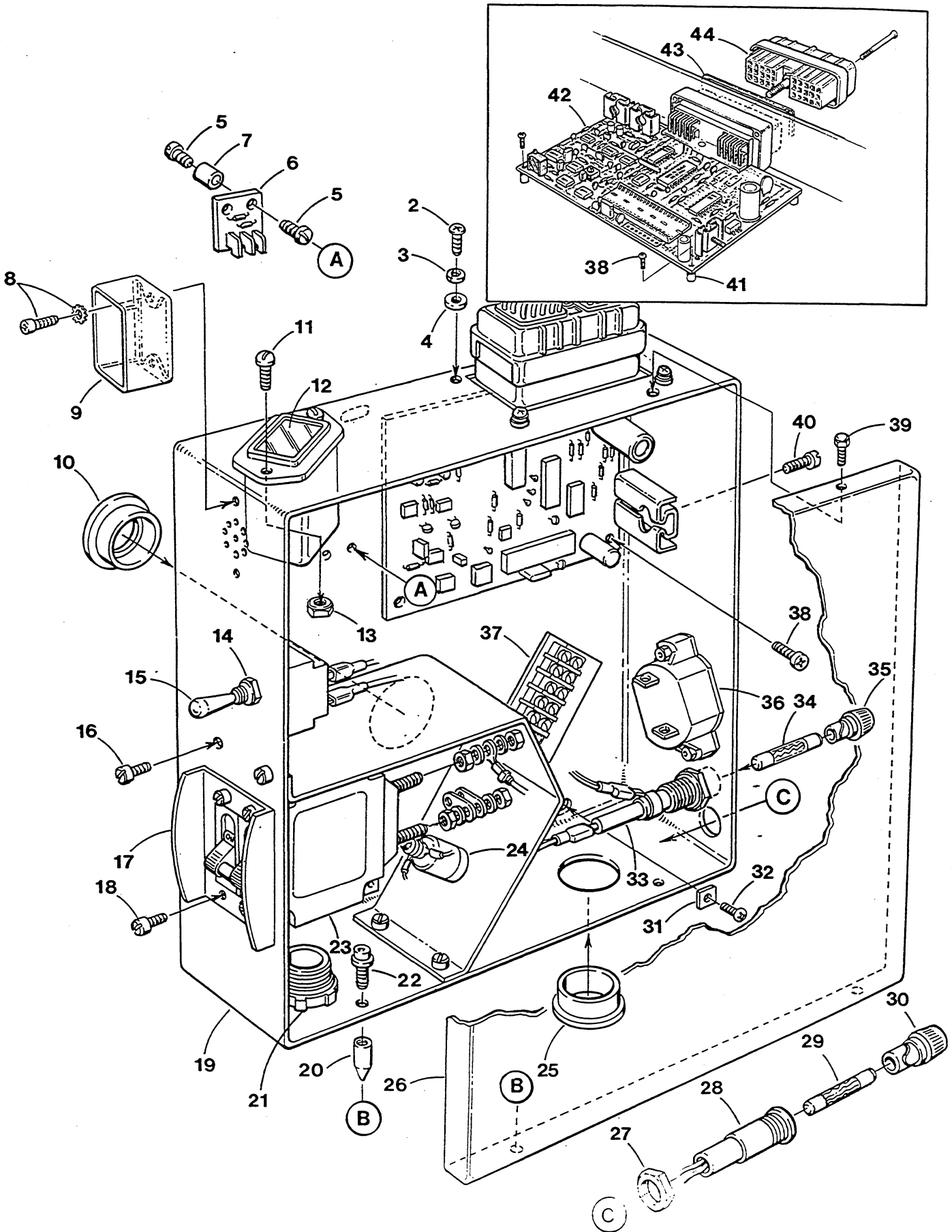

WESTERBEKE 4.5-7.2 BCGTE - GENERATOR CONTROL PANEL

REF	PN	NAME	REMARKS	QUAN
1	042484	PANEL	CONTROL INCL HARNESS EXCL AC BREAKER	1
2	042819	SCREW	4-40 X 5/16 SS	4
3	031895	LOCKWASHER	4 SS	4
4	031894	WASHER	4 FLAT SS	4
5	043250	SCREW	6-32 X 3/16 SS	4
6	043523	DIODE	PC BOARD ASSEMBLY	1
7	050496	STANDOFF		2
8	031940	SCREW	6-32 X 3/8 W/LOCKWASHER	2
9	042253	DUCT	AIR IN	1
10	023937	BUSHING		1
11	031853	SCREW	6-32 X 3/8 SS BH	2
12	042388	HOURLMETER		1
13	050234	NUT	6-32 KEPS	2
14	038042	NUT	SWITCH	1
15	042486	SWITCH	TOGGLE	1
16	031940	SCREW	6-32 X 3/8 W/LOCKWASHER	4
17	039082	GUARD	AC BREAKER	1
18	031852	SCREW	6-32 X 1/4 SS BH	4
19	043415	BOX	PANEL	1
20	030775	GUIDE		2
21	042909	CONNECTOR	BOX 1"	1
22	031940	SCREW	6-32 X 3/8 W/LOCKWASHER	2
23-1	043293	BREAKER	AC 20AMP 4.5KW 60HZ 3.75KW 50HZ	1
23-2	043294	BREAKER	AC 30AMP 7.2KW 60HZ 6.0KW 50HZ	1
24-1	043086	TERMINAL		1
24-2	043093	STUD	1/4NC X 1	1
24-3	031501	CAPSCREW	1/4NC X 1/2	1
24-4	031750	NUT	1/4NC HEX	1
24-5	031752	LOCKWASHER	1/4	2
24-6	031753	WASHER	1/4 FLAT	2
25	042933	BOOT		1
26	043411	COVER	PANEL BOX	1
27		NUT	FUSE HOLDER	1
28	043828	HOLDER	FUSE	1
29	043634	FUSE	30 AMP	1
30	043829	CARRIER	FUSE	1

WESTERBEKE 4.5-7.2 BCGE - GENERATOR CONTROL PANEL

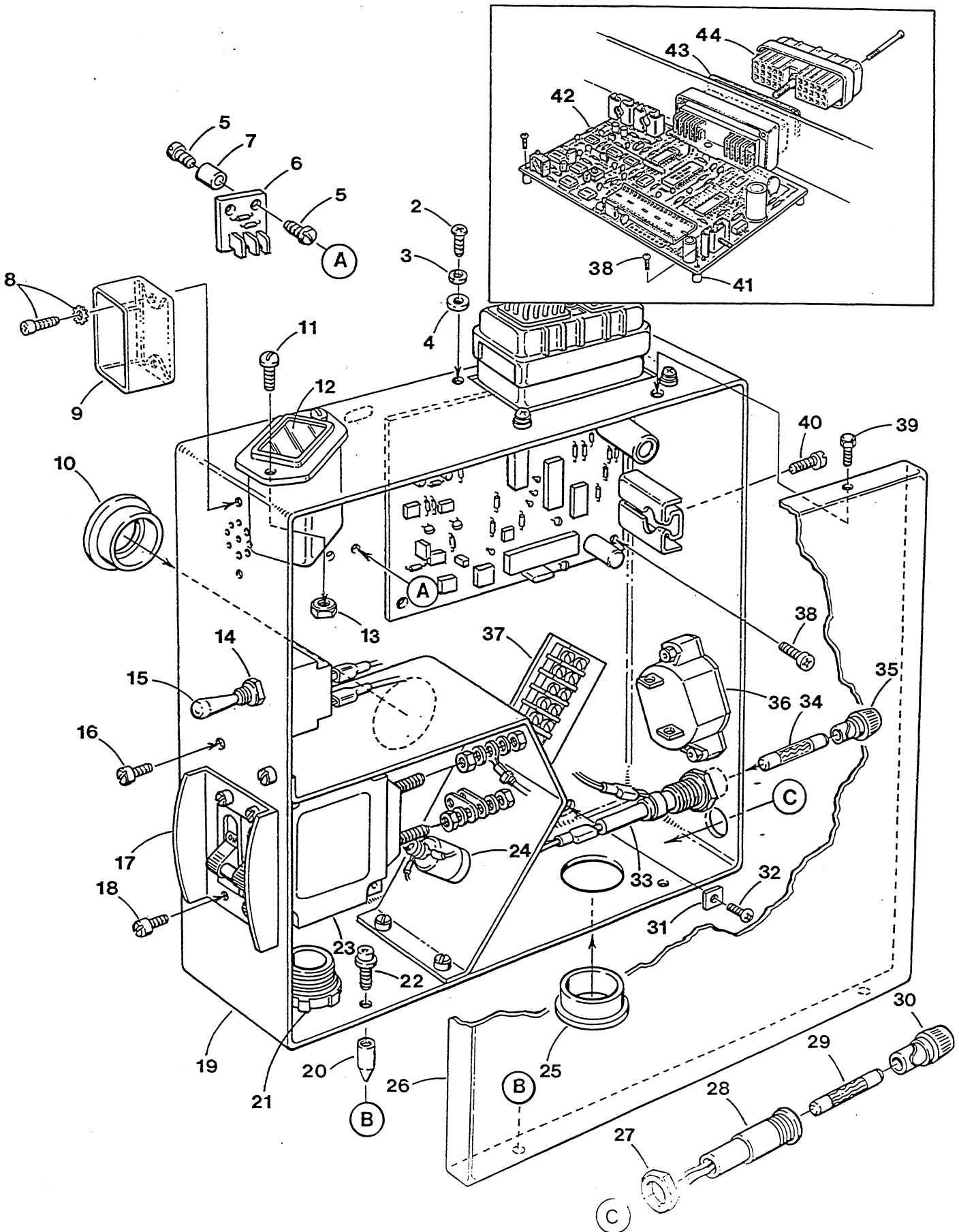

WESTERBEKE 4.5-7.2 BCGTE - GENERATOR CONTROL PANEL

REF	PN	NAME	REMARKS	QUAN
31	042628	WASHER	PANEL MOUNTING	3
32	031937	SCREW	8-32 X 3/8 W/LOCKWASHER	3
33	033767	HOLDER	FUSE INCLUDING CAP	1
34	042495	FUSE	2 AMP	1
35		CAP	FUSE HOLDER SEE REF 33	1
36-1	043422	BREAKER	CIRCUIT 25 AMP	1
36-2	031865	SCREW	8-32 X 3/4 SS BH	2
36-3	031843	WASHER	8 FLAT SS	2
37-1	042496	BLOCK	TERMINAL 6 POSITION	1
37-2	042498	MARKER	TERMINAL BLOCK	1
37-3	013855	PLATE	SCREW	1
37-4	031853	SCREW	6-32 X 3/8 SS BH	2
37-5	031854	SCREW	6-32 X 1/2 SS BH	2
37-6	042497	JUMPER		1
38	042819	SCREW	4-40 X 5/16 SS	8
39	043410	THUMBSCREW	6-32 X 3/8 SS	2
40	043243	HANDLE	HEAT SINK TO BOX	1
41	043246	STANDOFF	NYLON	4
42	043521	CONTROL	EFI	1
43	042528	SEAL	CONNECTOR	1
44	042618	HARNESS	GENSET	1

WESTERBEKE 4.5-7.6 BCGTE - ELECTRICAL SYSTEM

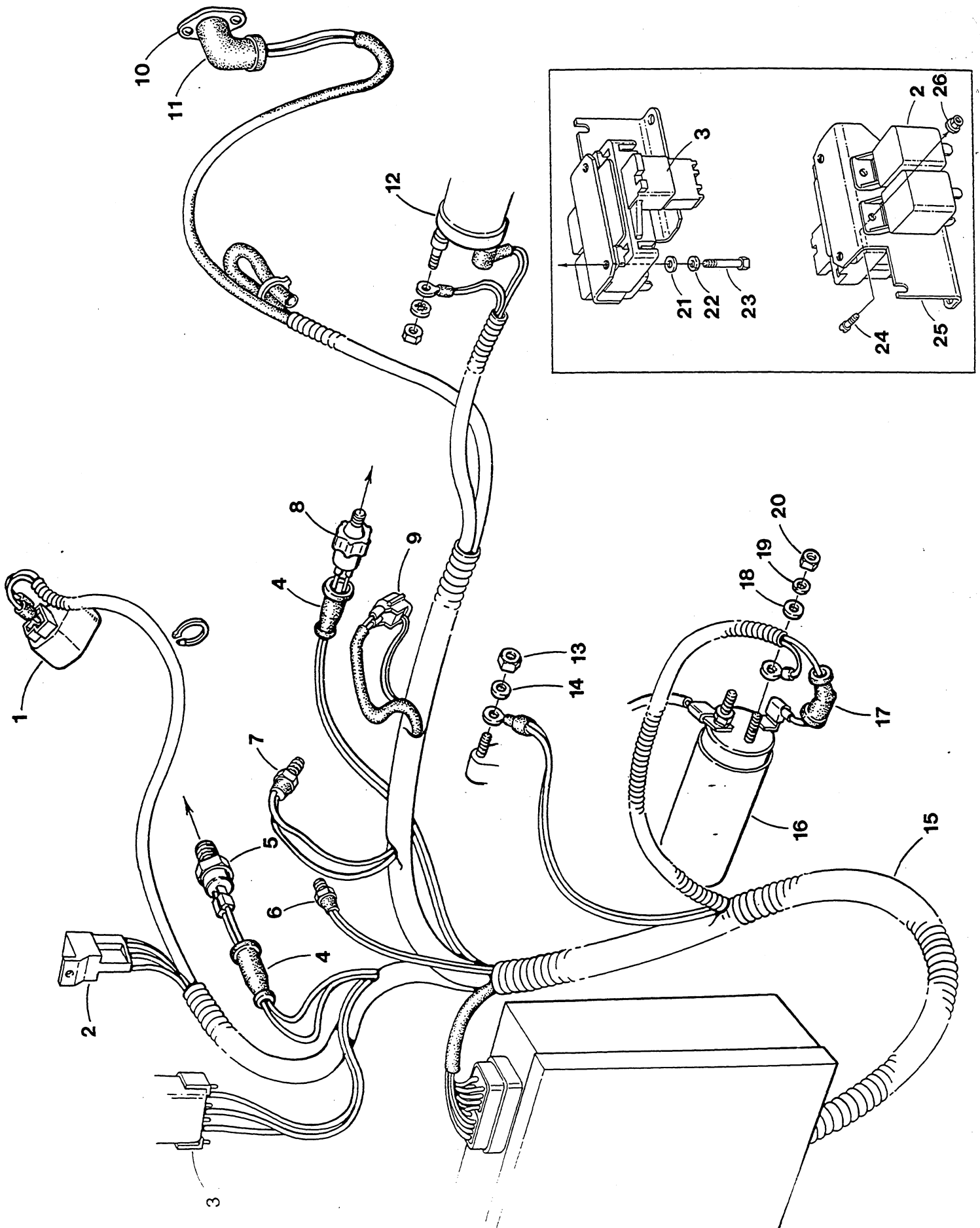

WESTEBEKE 4.5-7.2 BCGTE - ELECTRICAL SYSTEM

REF	PN	NAME	REMARKS	QUAN
1	042520	COIL	IGNITION	1
2	041150	RELAY	12VDC 30AMP	2
3	042130	SENSOR	MANIFOLD ABSOLUTE PRESSURE	1
4	035755	BOOT		2
5	039550	SWITCH	WATER TEMPERATURE	1
6	042749	SENSOR	WATER	1
7	042748	SENSOR	AIR	1
8	037323	SWITCH	OIL PRESSURE	1
9	042222	CONNECTOR	FUEL INJECTOR	1
10	032923	SWITCH	EXHAUST TEMPERATURE	1
11	035754	BOOT		1
12	042190	PUMP	ELECTRONIC FUEL	1
13	031803	NUT	M10 DIN 936	2
14-1	031789	WASHER	M10 DIN 125	2
14-2	019262	LOCKWASHER	M10 DIN 127	1
15	042618	HARNESS	GENSET	1
16	036218	SOLENOID	STARTER	1
17	034472	BOOT		1
18	031787	WASHER	M 8 DIN 125	1
19	031786	LOCKWASHER	M 8 DIN 127	1
20	018242	NUT	M 8 DIN 934	1
21	031784	WASHER	M 6 DIN 125	2
22	031783	LOCKWASHER	M 6 DIN 127	2
23	013590	CAPSCREW	M 6 X 30 DIN 933	2
24	031872	SCREW	10-32 X 1/2 SS BH	2
25	042287	BRACKET	MAP SENSOR & RELAYS	1
26	200125	NUT	10-32 KEPS	2

WESTERBEKE 4.5-7.2-9.6 BCGTC/E - REMOTE CONTROL PANELS

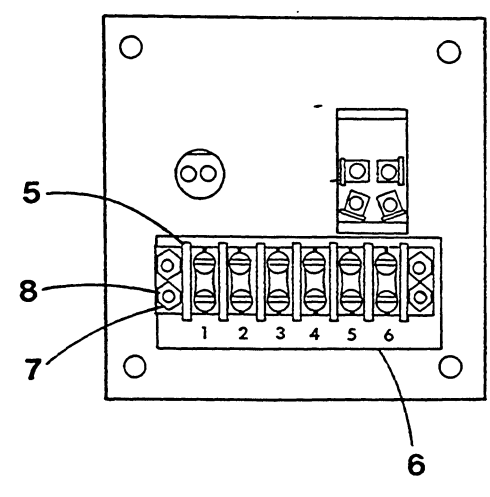
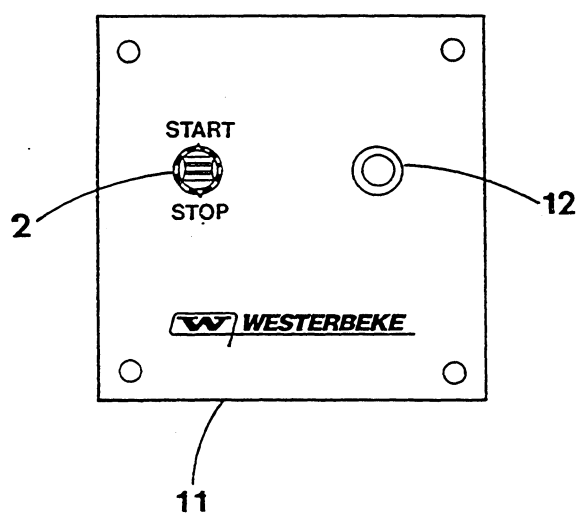
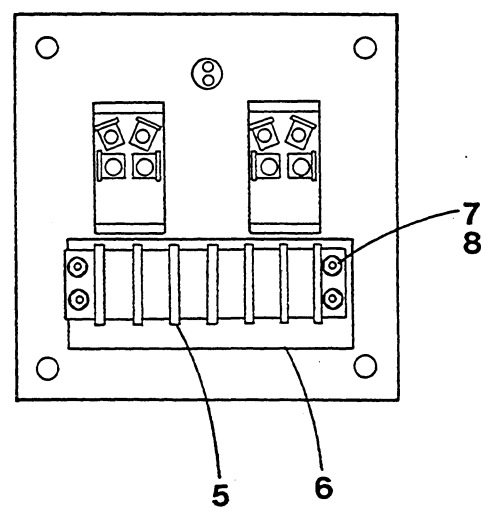
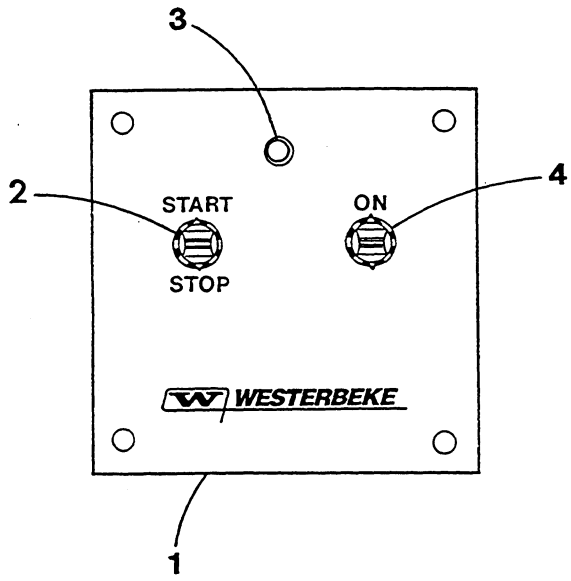

WESTERBEKE 4.5-7.2-9.6 BCGTC/E - REMOTE CONTROL PANELS

REF	PN	NAME	REMARKS	QUAN
1	042826	PANEL	REMOTE CONTROL BCGTC	1
2	042521	SWITCH	TOGGLE START-STOP	1
3	032975	LED	GREEN	1
4	033632	SWITCH	TOGGLE	1
5	042496	BLOCK	TERMINAL 6 POSITION	1
6	042498	MARKER	TERMINAL BLOCK	1
7	050559	NUT	6-32 SMALL HEX SS	4
8	031839	LOCKWASHER	6	4
9	013724	DIODE	LED 32975	1
10	013723	RESISTOR	LED 32975	1
11	042610	PANEL	REMOTE CONTROL BCGTE	1
12	042499	LED	RED	1

WESTERBEKE 4.5-7.2-9.6 BCGTC/E - SOUND GUARD

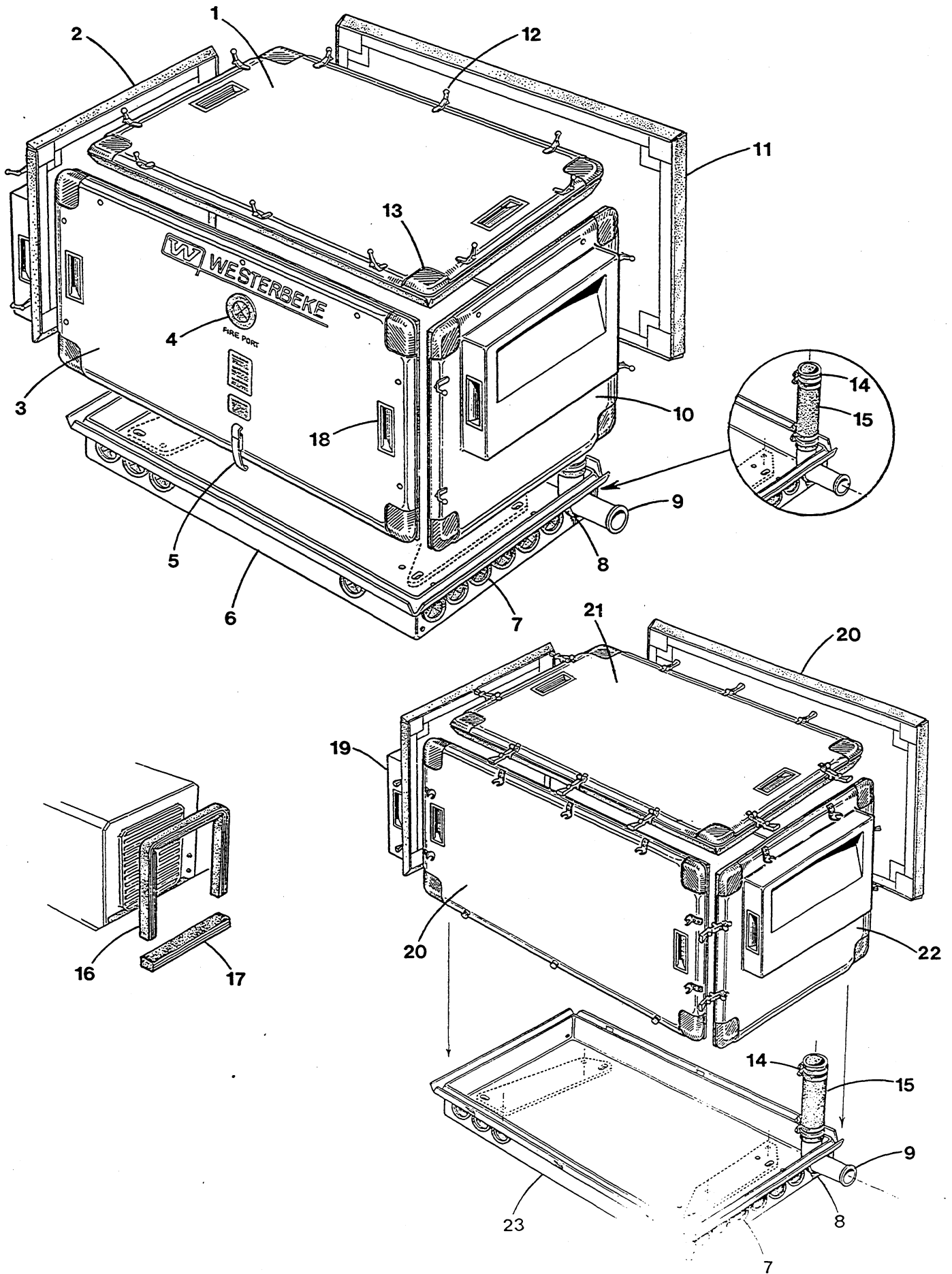

WESTERBEKE 4.5-7.2-9.6 BCGTC/E - SOUND GUARD

REF	PN	NAME	REMARKS	QUAN
1	044372	PANEL	TOP ASSEMBLY	1
2	044374	PANEL	REAR ASSEMBLY	1
3	044373	PANEL	SIDE ASSEMBLY	2
4	039498	BUSHING	FIRE PORT	2
5	044080	CLASP	PANEL TO BASE	2
6	044370	BASE	ASSEMBLY INCL 7-8-9-14-15-17	1
7	042780	BUSHING		10
8	042782	GROMMET	EXHAUST ELBOW	1
9	042815	ELBOW	EXHAUST	1
10	044371	PANEL	FRONT ASSEMBLY	1
11	043248	GASKET	SEAL PANELS - INCHES REQUIRED	AR
12	043775	LATCH	NEOPRENE	18
13	042638	CORNER	PANEL	20
14	011411	CLAMP	HOSE 32	4
15	030901	HOSE	2" WIRE INSERTED - INCHES REQUIRED	AR
16	043616	GASKET	UPPER	1
17	043575	GASKET	LOWER	1
18	042630	HANDLE		8
19	042853	PANEL	REAR ASSEMBLY VER 1 TO OCT 99	1
20	042854	PANEL	SIDE ASSEMBLY VER 1 TO OCT 99	2
21	042855	PANEL	TOP ASSEMBLY VER 1 TO OCT 99	1
22	042856	PANEL	FRONT ASSEMBLY VER 1 TO OCT 99	1
23	043143	BASE	ASSEMBLY VER 1 TO OCT 99	1

WESTERBEKE 4.5-7.2-9.6 BCGTC/E - MISCELLANEOUS

REF	PN	NAME	REMARKS	QUAN
1-1	042941	KIT A	SPARE PARTS BCGTC	1
1-2	043072	KIT A	SPARE PARTS BCGTE	1
2-1	042942	KIT B	SPARE PARTS-EXTENDED CRUISING BCGTC	1
2-2	043073	KIT B	SPARE PARTS-EXTENDED CRUISING BCGTE	1
3-1	042943	GASKET SET	UPPER BCGTC	1
3-2	043074	GASKET SET	UPPER BCGTE	1
4-1	042944	GASKET SET	COMPLETE BCGTC	1
4-2	043075	GASKET SET	COMPLETE BCGTE	1
5	015010	STRAINER	SEA WATER	1
6	033327	VALVE	ANTI-SIPHON	1
7-1	013758	PAINT	RED AEROSOL SPRAY CAN	1
7-2	042307	PAINT	WHITE AEROSOL SPRAY CAN	1
8	040078	FILTER KIT	REMOTE LUBE OIL	1
9-1	042832	MANUAL	OPERATOR BCGTC	1
9-2	042595	MANUAL	OPERATOR BCGTE	1
10	044518	MANUAL	SERVICE	1
11-1	032009	SWITCH	SHIP-SHORE 2 WIRE	1
11-2	032008	SWITCH	SHIP-SHORE 3 WIRE	1
12-1	034936	MUFFLER	HUDRO HUSH C	1
12-2	033340	CONNECTOR	HOSE-STRAIGHT 1-7/8	AR
12-3	033341	CONNECTOR	HOSE 45 DEGREE 1-7/8	AR
12-4	033342	CONNECTOR	HOSE 90 DEGREE 1-7/8	AR
12-5	036680	ADAPTER	1-7/8 TO 2 HOSE	AR
12-6	033943	KIT	HOSE COUPLING & CLAMPS	1
13-1	032550	MUFFLER	FIBREGLASS SIDE IN	1
13-2	041215	MUFFLER	FIBREGLASS TOP IN	1

PART NO	PAGE	REF	PART NO	PAGE	REF	PART NO	PAGE	REF
011341	141	9	015830	135	12	024905	115	30
011341	143	16	016692	117	24	024906	141	40
011357	121	2	017012	115	35	024906	143	9
011357	125	17	017012	115	43	024907	117	6
011357	127	15	017012	119	15	024907	141	41
011386	119	22	017012	125	22	024922	115	29
011386	121	8	017012	127	19	024950	143	19
011386	129	19	017012	129	16	024951	143	28
011405	117	12	017012	131	13	024951	147	50
011405	119	9	017012	137	17	024952	143	23
011411	163	14	017012	143	27	024977	117	33
011471	117	25	017012	147	69	024983	135	4
011796	139	15	017012	153	12	030237	103	6
011885	119	17	017196	115	19-1	030242	109	15
013339	129	5	017196	135	20-1	030711	101	1
013339	141	7	018241	141	27	030711	101	13
013340	129	6	018242	117	32	030712	101	5
013341	101	14	018242	135	16	030775	149	17
013343	129	4-3	018242	153	16	030775	155	20
013343	129	10-3	018242	159	20	030901	163	15
013343	139	2-3	018248	141	29	031228	147	48
013344	129	4-2	018804	117	1-2	031282	101	7
013344	129	10-2	018804	121	4	031501	149	20-3
013344	139	2-2	018804	121	18	031501	155	24-3
013345	129	4-1	019262	115	2	031553	145	31
013345	129	10-1	019262	125	27	031555	145	30
013346	139	2-1	019262	143	20	031750	137	23-1
013590	103	7	019262	143	31	031750	149	20-4
013590	125	32	019262	147	41	031750	155	24-4
013590	127	10	019262	147	49	031752	137	22-1
013590	159	23	019262	147	54	031752	149	20-5
013619	115	10	019262	153	15-2	031752	155	24-5
013629	143	30	019262	159	14-2	031753	149	20-6
013629	147	40	019321	119	19	031753	155	24-6
013630	115	26	019364	125	7	031758	145	29
013630	119	8	019364	139	17	031759	145	28
013630	121	16	019369	115	8	031780	129	13
013630	135	20-2	019369	119	12	031780	131	9
013630	145	19	019369	135	3-1	031780	141	5
013630	147	52	019369	135	7-1	031780	141	23
013723	161	10	019369	135	23	031780	141	28
013724	161	9	020628	117	1-1	031780	141	35
013758	164	7-1	021448	129	7	031781	129	14
013855	151	33-4	021558	115	12	031781	141	4
013855	157	37-3	021722	125	35	031781	141	24
013919	147	45	021722	127	8	031783	115	34
014277	145	33	022850	119	20	031783	115	41
015010	164	5	022851	119	18	031783	117	2
015812	115	40	022852	119	21	031783	117	19
015812	121	11	023809	153	7	031783	119	14
015812	137	11	023937	149	10	031783	121	10
015812	137	23-2	023937	155	10	031783	121	19
015812	141	31	024306	117	4	031783	125	21
015812	143	24	024349	101	21	031783	125	33
015830	103	13	024374	101	3	031783	127	9
015830	103	17	024374	103	21	031783	127	20
015830	105	10	024374	105	18	031783	129	17
015830	105	14	024601	115	7-2	031783	131	14

PART NO	PAGE	REF	PART NO	PAGE	REF	PART NO	PAGE	REF
031783	137	3	031843	155	36-3	033038	123	12
031783	137	10	031847	125	5	033041	123	10
031783	137	18	031847	139	21	033042	123	17
031783	137	22-2	031848	139	18	033044	123	19
031783	141	30	031849	125	6	033045	123	18
031783	143	25	031849	139	20	033212	101	10
031783	145	22	031852	149	8	033228	125	31
031783	147	68	031852	149	16	033228	127	7
031783	153	11	031852	155	18	033327	164	6
031783	159	22	031853	149	6	033340	164	12-2
031784	115	42	031853	155	11	033341	164	12-3
031784	117	3	031853	157	37-4	033342	164	12-4
031784	117	18	031854	151	33-5	033372	125	30
031784	121	9	031854	157	37-5	033372	127	6
031784	121	20	031865	151	32-2	033381	131	3
031784	137	4	031865	157	36-2	033381	145	27
031784	137	19	031872	159	24	033632	149	13
031784	145	21	031873	125	19	033632	161	4
031784	147	67	031889	137	6	033641	135	2
031784	159	21	031894	155	4	033668	109	28
031786	115	11	031895	155	3	033669	101	20
031786	115	19-2	031914	143	13	033669	101	24
031786	115	27	031917	143	18	033669	111	2
031786	117	31	031918	129	12	033669	111	5
031786	119	7	031918	145	5	033767	151	34
031786	121	15	031918	145	12	033767	157	33
031786	135	5	031918	145	15	033769	151	35
031786	135	15	031919	141	36	033885	131	1
031786	135	19	031929	143	17	033943	164	12-6
031786	145	20	031931	145	17	034213	137	2
031786	147	51	031937	151	37	034470	147	53
031786	153	17	031937	157	32	034472	153	19
031786	159	19	031940	149	2	034472	159	17
031787	115	28	031940	149	14	034552	147	57
031787	117	30	031940	149	21	034589	125	26
031787	119	6	031940	151	29	034589	147	58
031787	121	14	031940	155	8	034663	115	16
031787	135	6	031940	155	16	034936	164	12-1
031787	135	14	031940	155	22	035289	137	14
031787	135	18	032008	164	11-2	035291	139	19
031787	135	24	032009	164	11-1	035293	137	9
031787	153	18	032550	164	13-1	035337	137	21-1
031787	159	18	032617	121	6	035435	141	39
031789	115	3	032617	123	1	035711	117	23
031789	125	28	032620	123	2	035754	153	9
031789	143	21	032625	123	8	035754	159	11
031789	143	32	032923	117	22	035755	153	3
031789	147	56	032923	153	8	035755	159	4
031789	153	15-1	032923	159	10	035894	137	1
031789	159	14-1	032975	161	3	035894	137	13
031803	147	55	032996	147	47-2	035978	145	7-2
031803	153	14	033031	123	14	035979	145	6-1
031803	159	13	033032	123	4	035985	145	7-1
031826	141	13	033033	123	20	036218	153	20
031837	149	25	033034	123	16	036218	159	16
031838	151	27-2	033035	123	15	036275	139	23
031839	161	8	033036	123	9	036276	139	4
031843	151	32-3	033037	123	13	036423	125	8

PART NO	PAGE	REF
036654	119	23
036654	121	17-2
036680	164	12-5
036869	117	9
036869	117	28
036869	119	3
036869	135	11
036869	141	17
036869	141	19
036869	141	21
036916	101	12
036918	115	15
037323	115	9
037323	153	4
037323	159	8
037751	139	14
037819	139	16
037846	139	9
038038	139	12
038038	153	6
038041	139	25
038042	139	13
038042	149	11
038042	155	14
038074	103	8
038074	143	26
038090	139	3
038091	139	22
038092	139	6
038093	139	24
038094	139	10
038096	139	11
038097	139	5
038100	139	26
038193	137	15
038348	143	14
038469	145	13-2
038914	131	8
039082	149	15
039082	155	17
039172	147	44
039378	117	10
039498	163	4
039550	135	8
039550	153	2
039550	159	5
039949	143	12
040078	164	8
040088	147	39
040384	117	8
040384	117	27
040384	119	2
040384	135	10
040384	141	18
040455	123	21
040838	143	5
040878	143	6
040879	143	4

PART NO	PAGE	REF
041150	151	26
041150	159	2
041180	149	9
041199	145	7-3
041215	164	13-2
041323	115	13
041417	101	8
041417	107	10
041429	109	31
041460	147	42-2
041472	147	17-1
041569	131	4
041574	147	60
042020	115	20
042023	121	3
042034	115	44
042035	115	33
042076	135	1-2
042079	119	5
042110	115	21
042122	117	13
042124	117	14
042124	119	11
042126	121	7
042130	159	3
042135	141	33
042141	115	17
042147	119	4
042190	143	11
042190	159	12
042193	119	10
042221	141	26
042222	159	9
042228	117	5
042251	145	32-3
042252	117	29
042253	149	7
042253	155	9
042257	121	13
042258	117	21
042260	117	11
042264	119	16
042271	105	4
042273	115	23
042277	115	6
042281	121	5
042287	159	25
042290	131	12
042293	115	38
042294	147	66
042302	115	37
042302	147	64-1
042303	115	32
042303	147	63
042304	117	16
042307	164	7-2
042308	141	37
042309	141	25

PART NO	PAGE	REF
042311	137	20
042311	141	11
042374	145	32-1
042375	145	32-2
042377	149	22
042384	127	22
042388	149	5
042388	155	12
042410	143	7
042414	115	4-1
042431	105	5
042443	141	16
042445	141	1
042484	155	1
042486	155	15
042488	131	2
042488	133	1
042495	157	34
042496	151	33-1
042496	157	37-1
042496	161	5
042497	151	33-3
042497	157	37-6
042498	151	33-2
042498	157	37-2
042498	161	6
042499	161	12
042520	131	10
042520	153	1
042520	159	1
042521	149	12
042521	161	2
042528	157	43
042577	127	5
042578	125	34
042578	127	11
042579	127	21
042584	141	2
042595	164	9-2
042596	147	38-1
042598	147	59
042610	161	11
042611	115	5
042612	115	14
042616	117	7
042616	135	3-2
042616	135	9
042617	141	20
042618	157	44
042618	159	15
042625	141	12
042628	151	38
042628	157	31
042629	141	14
042630	163	18
042632	141	6
042632	141	22
042638	163	13

PART NO	PAGE	REF	PART NO	PAGE	REF	PART NO	PAGE	REF
042668	141	15	042825	137	12	042964	107	9
042669	143	2	042826	161	1	042964	147	46
042671	141	8	042830	125	20	042965	109	17
042680	141	10	042831	125	29	042966	111	12
042680	143	15	042832	164	9-1	042967	111	11
042681	143	22	042851	151	28-1	042968	103	11
042682	143	29	042853	163	19	042968	105	8
042688	103	10	042854	163	20	042969	113	16
042688	105	7	042855	163	21	042970	101	19
042689	135	17	042856	163	22	042971	109	7
042689	137	21-2	042865	129	1	042972	113	14
042692	141	38	042870	149	1-2	042973	113	15
042694	125	1	042870	153	21-1	042975	103	2
042724	117	17	042874	145	24	042975	105	2
042726	137	16	042884	149	24-2	042976	101	22
042727	143	10	042891	115	24	042977	109	8
042732	139	8	042894	109	27	042978	109	18
042735	149	1-1	042896	125	4	042979	109	19
042736	147	38-3	042909	149	18	042980	107	7
042737	129	15	042909	155	21	042980	125	23
042738	141	3	042912	103	4	042980	127	18
042748	141	42	042918	147	38-2	042981	101	6
042748	159	7	042926	143	8	042982	103	19-1
042749	135	7-2	042933	151	39	042982	105	16-1
042749	159	6	042933	155	25	042983	103	19-2
042771	125	2	042934	121	17-1	042983	105	16-2
042773	141	34	042934	129	20	042985	111	3
042774	121	1	042941	164	1-1	042985	111	8
042774	125	16	042942	164	2-1	042986	135	22
042774	127	14	042943	164	3-1	042987	109	12
042776	137	8	042944	164	4-1	042988	111	7
042776	139	1	042945	101	15	042989	111	10
042780	163	7	042946	103	12	042990	109	20
042781	149	3	042946	105	9	042991	131	5
042782	163	8	042947	111	9	042992	109	5
042790	125	18	042948	109	9	042993	109	6
042790	127	16	042949	103	15-1	042994	109	3
042794	143	1	042949	105	12-1	042995	109	4
042795	125	15	042950	103	15-2	042996	109	21
042795	127	17	042950	105	12-2	042997	113	2
042797	125	10	042951	103	15-3	042998	103	5
042797	127	13	042951	105	12-3	042999	109	16
042798	125	25	042952	109	13	043000	103	20-1
042800	125	24	042953	113	17	043000	105	17-1
042800	127	12	042954	109	32	043001	103	20-2
042806	145	10	042955	103	14-1	043001	105	17-2
042810	115	36	042955	105	11-1	043002	101	9
042810	147	65	042956	103	14-2	043003	101	17
042811	115	25	042956	105	11-2	043004	113	8
042815	163	9	042957	103	14-3	043005	125	12
042816	145	26	042957	105	11-3	043005	127	1
042817	143	3	042958	113	6	043007	111	6
042819	155	2	042959	113	7	043008	109	33
042819	157	38	042960	103	3	043009	109	30
042821	147	64-2	042960	105	3	043010	107	2-1
042822	125	9	042961	109	10	043011	109	2
042823	103	9	042962	109	14	043012	107	2-2
042825	129	18	042963	109	24	043013	107	2-3

PART NO	PAGE	REF	PART NO	PAGE	REF	PART NO	PAGE	REF
043014	107	1-1	043069	113	9	043481	115	18
043015	107	1-2	043070	101	2	043483	145	1-1
043016	107	1-3	043070	101	16	043497	145	1-3
043017	103	22	043071	131	7	043498	145	1-2
043017	105	19	043072	164	1-2	043521	157	42
043018	113	12	043073	164	2-2	043523	155	6
043019	111	1	043074	164	3-2	043524	145	3-1
043021	109	23	043075	164	4-2	043575	163	17
043022	113	13	043084	147	42-1	043585	125	3
043023	109	1	043086	149	20-1	043616	163	16
043024	109	25	043086	155	24-1	043623	145	11
043025	107	3	043093	149	20-2	043634	151	42
043027	101	18	043093	155	24-2	043634	155	29
043028	103	16	043096	145	13-1	043649	145	18
043028	105	13	043114	129	8-1	043651	101	4
043029	103	18	043115	129	9-1	043775	163	12
043029	105	15	043116	147	70	043800	139	7
043030	113	1	043124	129	11	043800	153	5
043031	111	4	043124	153	13	043809	125	13
043032	107	4	043125	129	2	043809	127	2
043033	107	6	043138	147	62	043818	149	1-5
043034	107	8	043139	115	31	043818	153	22
043036	109	22	043139	147	61	043828	151	41
043037	107	11	043143	163	23	043828	155	28
043038	107	12-1	043216	135	21	043829	151	43
043039	107	12-2	043240	149	24-1	043829	155	30
043040	107	12-3	043242	115	7-1	043897	149	1-3
043041	107	12-4	043242	153	10	043905	117	26
043042	107	12-5	043243	157	40	043905	119	1
043043	107	5-1	043246	157	41	043937	149	1-4
043044	107	5-2	043247	151	28-2	043937	153	21-2
043045	107	5-3	043248	163	11	044080	163	5
043046	101	23	043250	151	27-1	044356	137	5
043047	101	11	043250	155	5	044370	163	6
043048	113	5	043257	115	39	044371	163	10
043049	133	7	043282	119	13	044372	163	1
043050	133	3	043285	149	19-4	044373	163	3
043051	133	12	043287	135	13	044374	163	2
043052	133	8	043291	117	20	044391	117	15
043053	133	9	043293	149	19-1	044518	164	10
043054	133	10	043293	155	23-1	044756	129	8-2
043055	133	5	043294	149	19-2	044757	129	9-2
043056	133	4	043294	155	23-2	044939	145	4
043057	133	6	043295	149	19-3	044940	145	9-1
043058	133	11	043335	105	6	044941	145	9-2
043059	133	2	043345	129	3	044942	147	34
043060	131	6	043410	151	30	044943	145	23
043062	105	1	043410	157	39	044944	147	36-1
043063	103	1	043411	151	31	044945	147	36-2
043064	109	11	043411	155	26	044946	147	36-3
043065	113	3	043412	135	1-1	044947	145	2-2
043065	113	10	043415	149	4	044948	145	2-1
043065	125	11	043415	155	19	044949	145	8-1
043065	127	4	043417	115	4-2	044950	145	8-2
043066	113	4	043419	115	22	044951	145	8-3
043066	113	11	043422	151	32-1	044952	145	16-2
043067	109	29	043422	157	36-1	044953	145	16-3
043068	109	26	043438	137	7	044954	145	16-1

PART NO	PAGE	REF
044955	147	37
044956	147	35
044957	145	3-2
044958	145	3-3
044959	145	6-2
044960	145	14
050208	141	32
050234	149	23
050234	155	13
050496	155	7
050559	161	7
200125	159	26
200442	121	21
298616	115	1
301590	125	14
301590	127	3
302575	123	11

